

Kood Haus Perlund	Leht 1
Joonis SEIN A	Mootkava 1:50
Materjal 2.8x11.4	Kuup. 09.10.2019
Joonestas	File Haus Perlund 28n

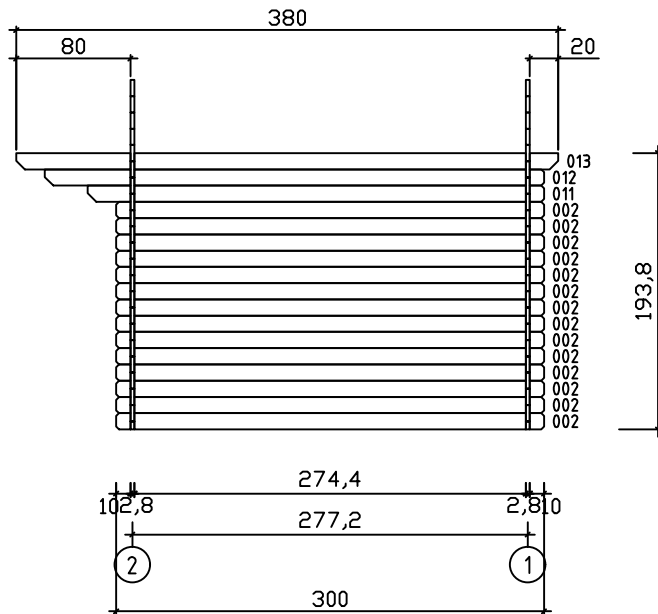





Sein A ↗

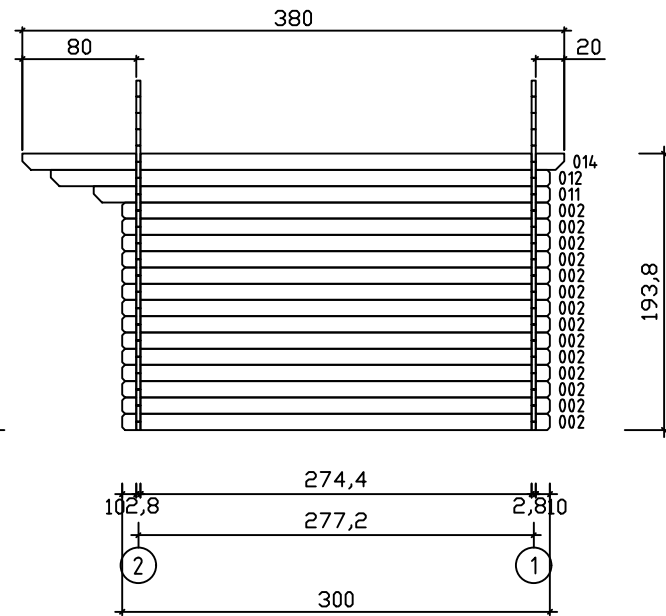

Sein B ↗

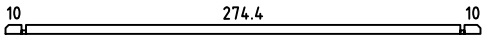
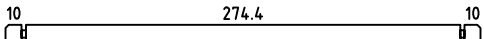
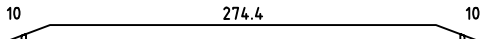
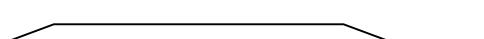
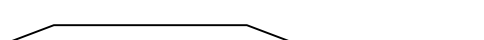

Kood	Haus Perlund	Leht	1
Joonis	SEIN A	Mootkava	1:50
Materjal	2,8x11,4	Kuup.	09.10.2019
Joonestas	File Haus Perlund 28r		

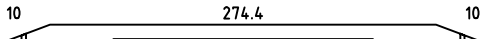
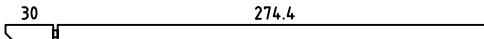
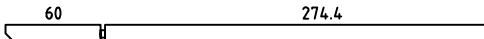
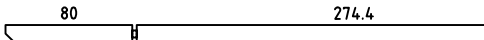
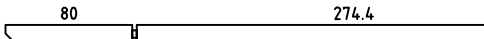
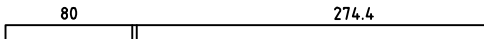
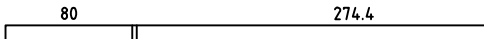
Pos	Joonis Haus Perlund	Pcs	Profiil (cm)	Pikkus (cm)
001		1	2.8x5.7	300
002		44	2.8x11.4	300
003		1	2.8x11.4	300
004		2	2.8x11.4	243.9
005		2	2.8x11.4	182.9
006		2	2.8x11.4	122
007		4	2.8x10.8	28.8
008		2	2.8x5.7	68
009		32	2.8x11.4	68
010		1	2.8x11.4	300
011		2	2.8x11.4	320
012		2	2.8x11.4	350
013		1	2.8x11.4	380
014		1	2.8x11.4	380
PR1		2	4.3x14.5	380
PR2		1	4.3x14.5	380
	DOOR 162x188	1		
015	ROOF BOARDS/DACHBRETTER/VOLIGE	68 56	11.2x1.6 13.7x1.6	171 171
016	ROOF EDGE REINFORCEMENT/TRAUFENLEISTE/TASSEAU	2	2.6x3.2	380
017	ROOF SIDE BOARDS/TRAUFENBRETT/PLANCHE DE RIVE	2	1.8x6	380
018	FASCIA BOARD/GIEBELBLENDE/PLANCHE DE RIVE (FACADE)	4	1.8x12.0	176
019	FASCIA BOARD/GIEBELBLENDE/PLANCHE DE RIVE (FACADE)	4	1.8x6.0	176
020	DIAMOND/RAUTE/DIAMANT	2	1.8x12	

Kood Haus Perlund

Materjal

File Haus Perlund 28mm Reinhold 11 lõigatu

