

Kood	Haus Bo 28mm	Leht	1
Joonis	SEIN A	Mootkava	1:50
Materjal	2.8x11.4	Kuup.	08.10.2019
Joonestas	File Haus Bo 28mm nu		

Sein A ↗

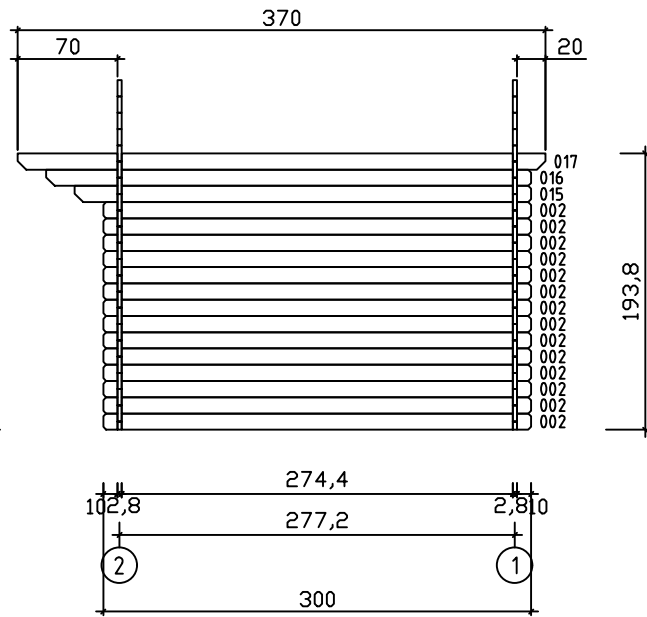

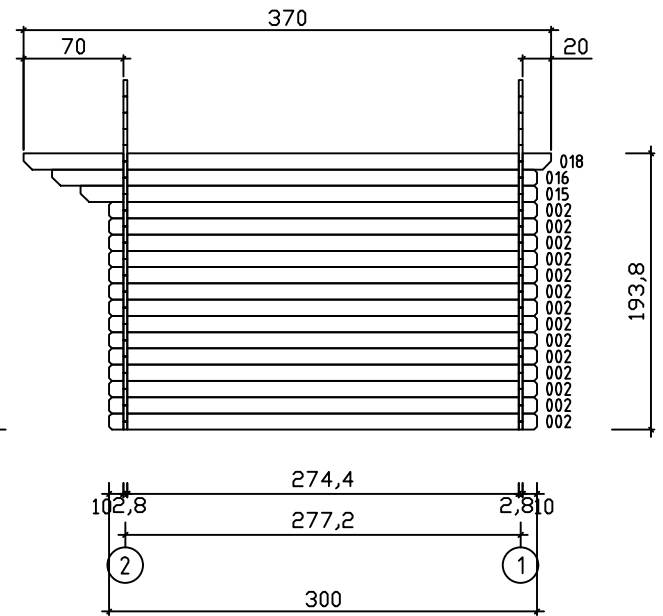



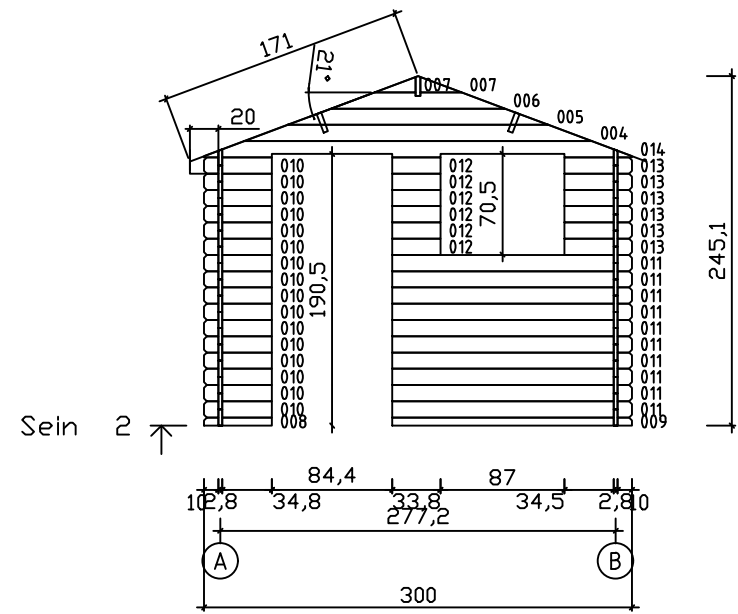
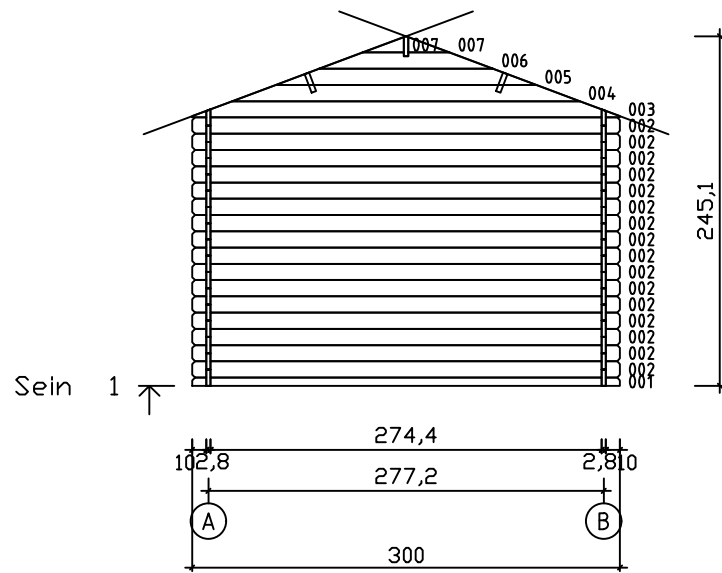

Sein B ↗

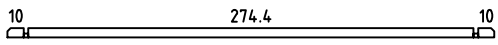
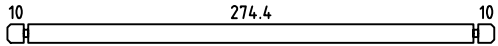
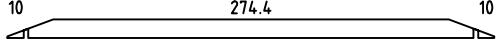
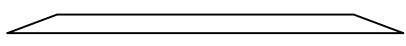
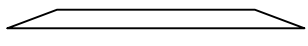
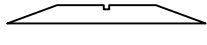

Kood	Haus Bo 28mm	Leht	1
Joonis	SEIN A	Mootkava	1:50
Materjal	2.8x11.4	Kuup.	08.10.2019
Joonestas		File	Haus Bo 28mm nu

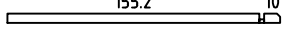

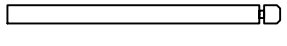

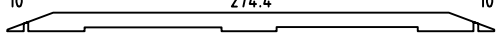
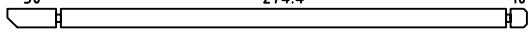
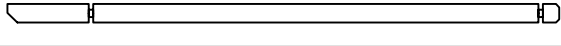
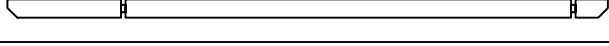
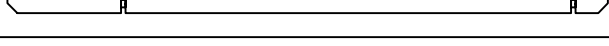
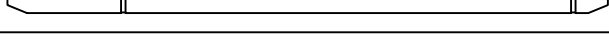
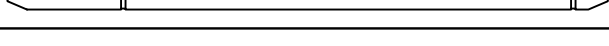



Kood	Haus Bo 28mm	Leht	3
Joonis	SEIN 1	Mootkava	1:50
Materjal	2.8x11.4	Kuup.	08.10.2019
Joonestas	File Haus Bo 28mm nu		

Pos	Joonis Haus Bo 28mm	Pcs	Profiil (cm)	Pikkus (cm)
001		1	2.8x5.7	300
002		44	2.8x11.4	300
003		1	2.8x11.4	300
004		2	2.8x11.4	243.9
005		2	2.8x11.4	182.9
006		2	2.8x11.4	122
007		4	2.8x10.8	28.8
008		1	2.8x5.7	47.6
009		1	2.8x5.7	168
010		16	2.8x11.4	47.6
011		10	2.8x11.4	168
012		6	2.8x11.4	33.8
013		6	2.8x11.4	47.3
014		1	2.8x11.4	300
015		2	2.8x11.4	320
016		2	2.8x11.4	340
017		1	2.8x11.4	370
018		1	2.8x11.4	370
PR1		2	4.3x14.5	370
PR2		1	4.3x14.5	370
	WINDOW 85x68	1		
	DOOR 83x188	1		

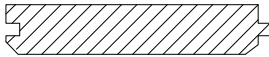
Kood Haus Bo 28mm

Materjal

File Haus Bo 28mm nurgahõltsid.dwg

Pos	Drawing Haus Bo 28mm		Pcs	Profile (cm)	Length (cm)
019	ROOF BOARDS/DACHBRETTER/VOLIGE		66 54	11.2x1.6 13.7x1.6	171 171
020	ROOF EDGE REINFORCEMENT/TRAUFENLEISTE/TASSEAU		2	2.6x3.2	370
021	ROOF SIDE BOARDS/TRAUFENBRETT/PLANCHE DE RIVE		2	1.8x6	370
022	FASCIA BOARD/GIEBELBLENDE/PLANCHE DE RIVE (FACADE)		4	1.8x12.0	176
023	FASCIA BOARD/GIEBELBLENDE/PLANCHE DE RIVE (FACADE)		4	1.8x6.0	176
024	DIAMOND/RAUTE/DIAMANT		2	1.8x12	
Kood Haus Bo 28mm		Materjal	File Haus Bo 28mm nurgelentig.tud.dwg		

