

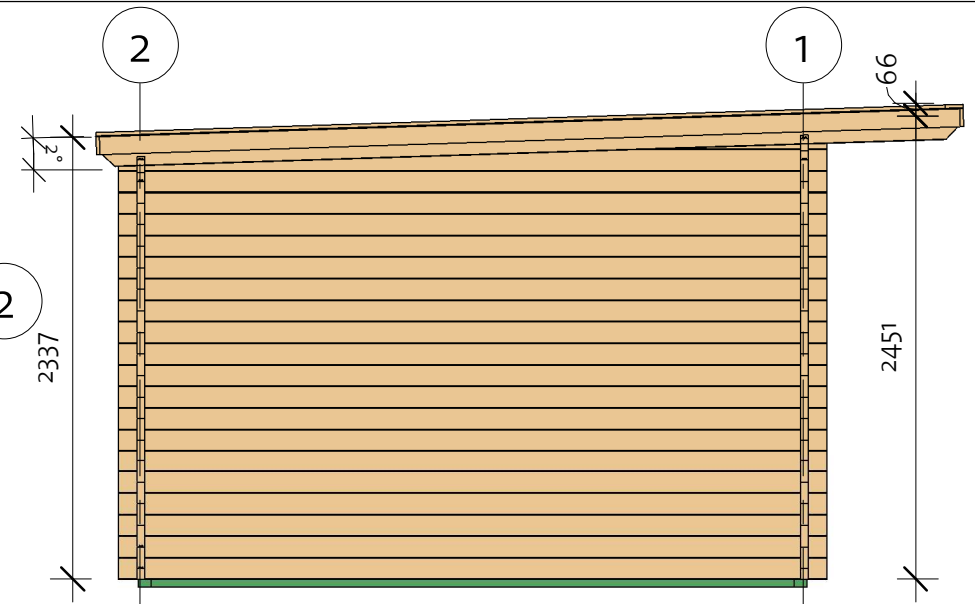

Meribel 40 (560x355)

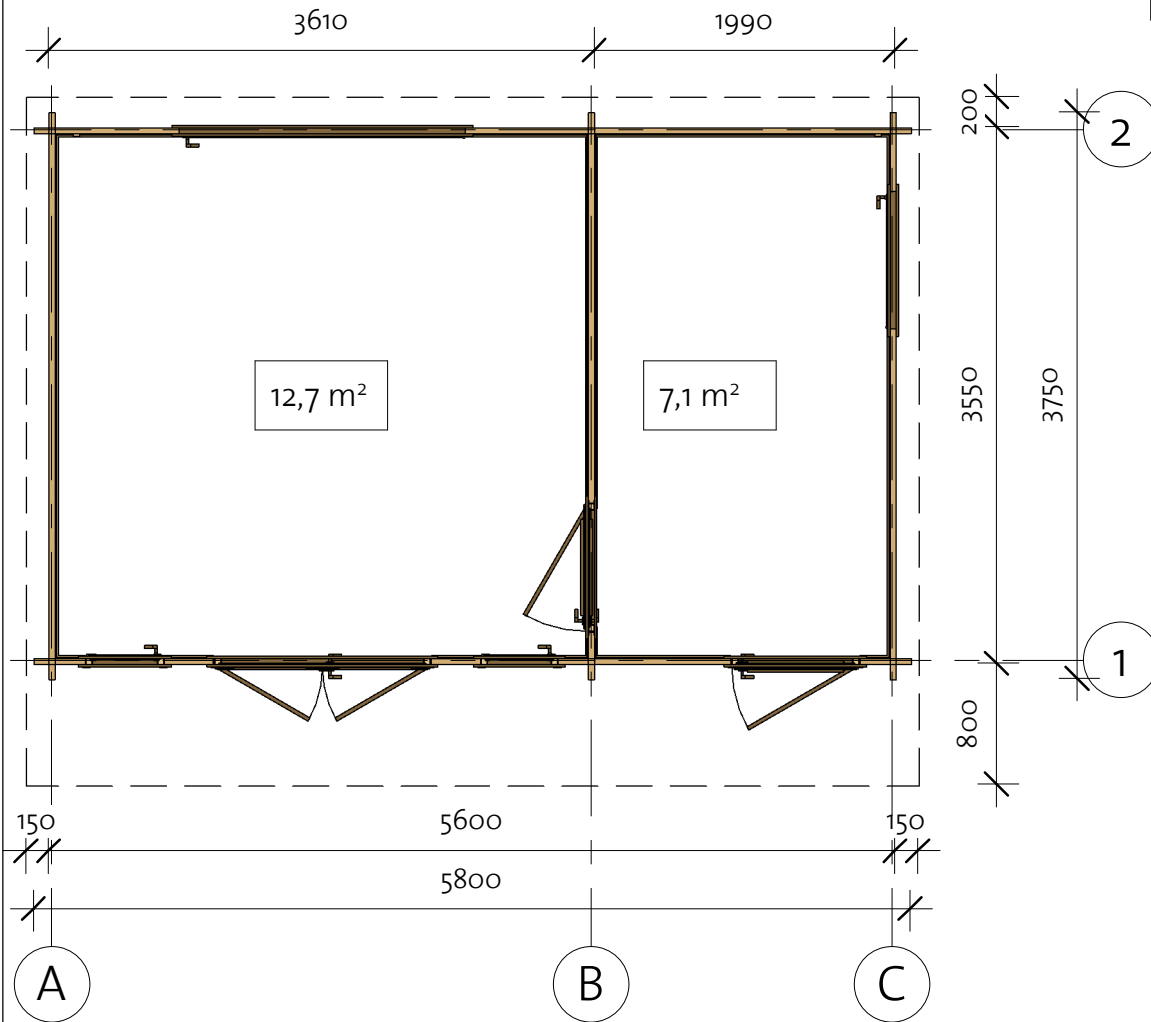
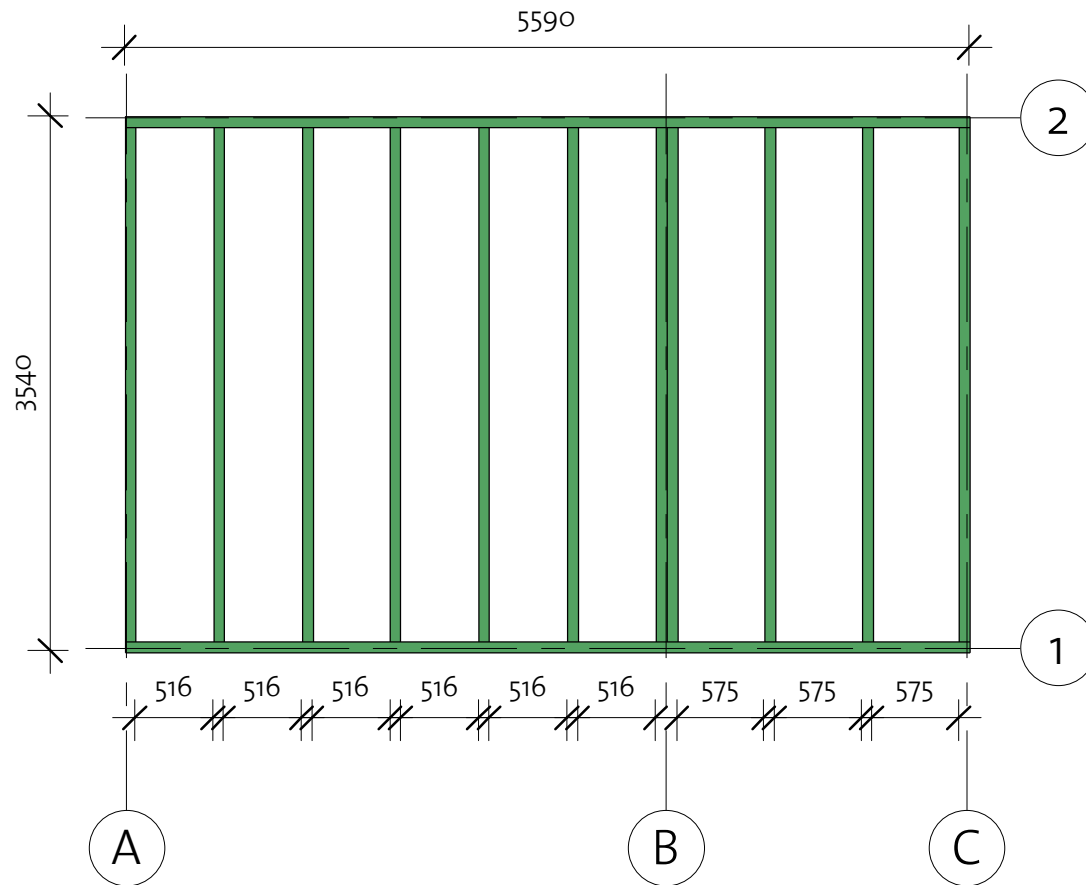

Meribel 40 (560x355)

Foundation





Impregnated foundation beams				
Mark	Type	Profile	Count	Length
IFB1	IFB 70x40		2	5590
IFB2	IFB 70x40		11	3400

Meribel 40 (560x355)

Floor Plan

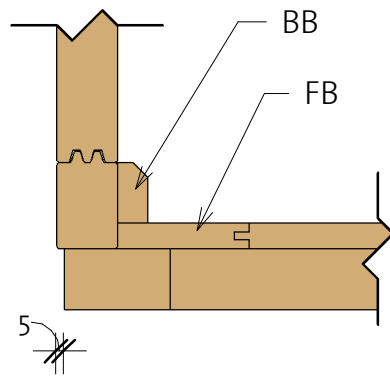
① Baseboard



Floor Schedule				
Mark	Type	Profile	Count	Length
FB1	FB 17x114		32	3524
FB2	FB 17x114		32	1944
BB1	BB 20x40		4	3600
BB2	BB 20x40		2	5600

92105142_210526

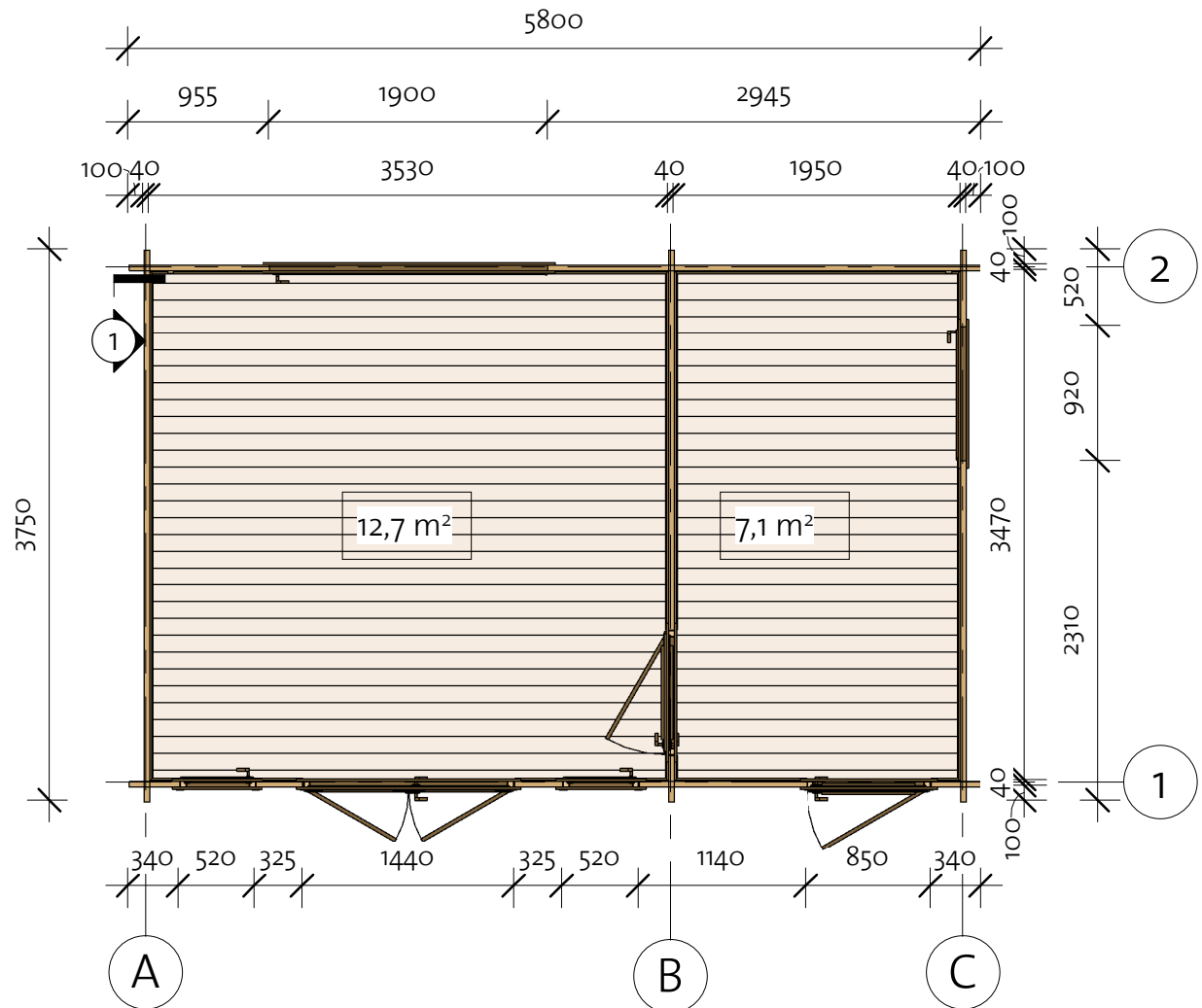

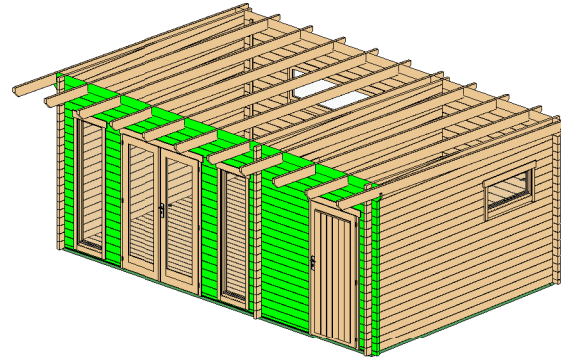

Meribel 40 (560x355)

Wall 1



Wall 1			
Mark	Profile	Count	Cut Length
1BL-1	40x57	1	340
1BL-2	40x57	1	1185
1BL-3	40x57	1	1985
1LG-1	40x114	34	325
1LG-2	40x114	34	340
1LG-3	40x114	17	1140
1LG-4	40x114	2	5800
1LG-5	40x114	1	5900
1TL-1	40x114	1	5900

Log Profile Wall 1	
Profile	Profile

40x57	
40x114	
40x114	

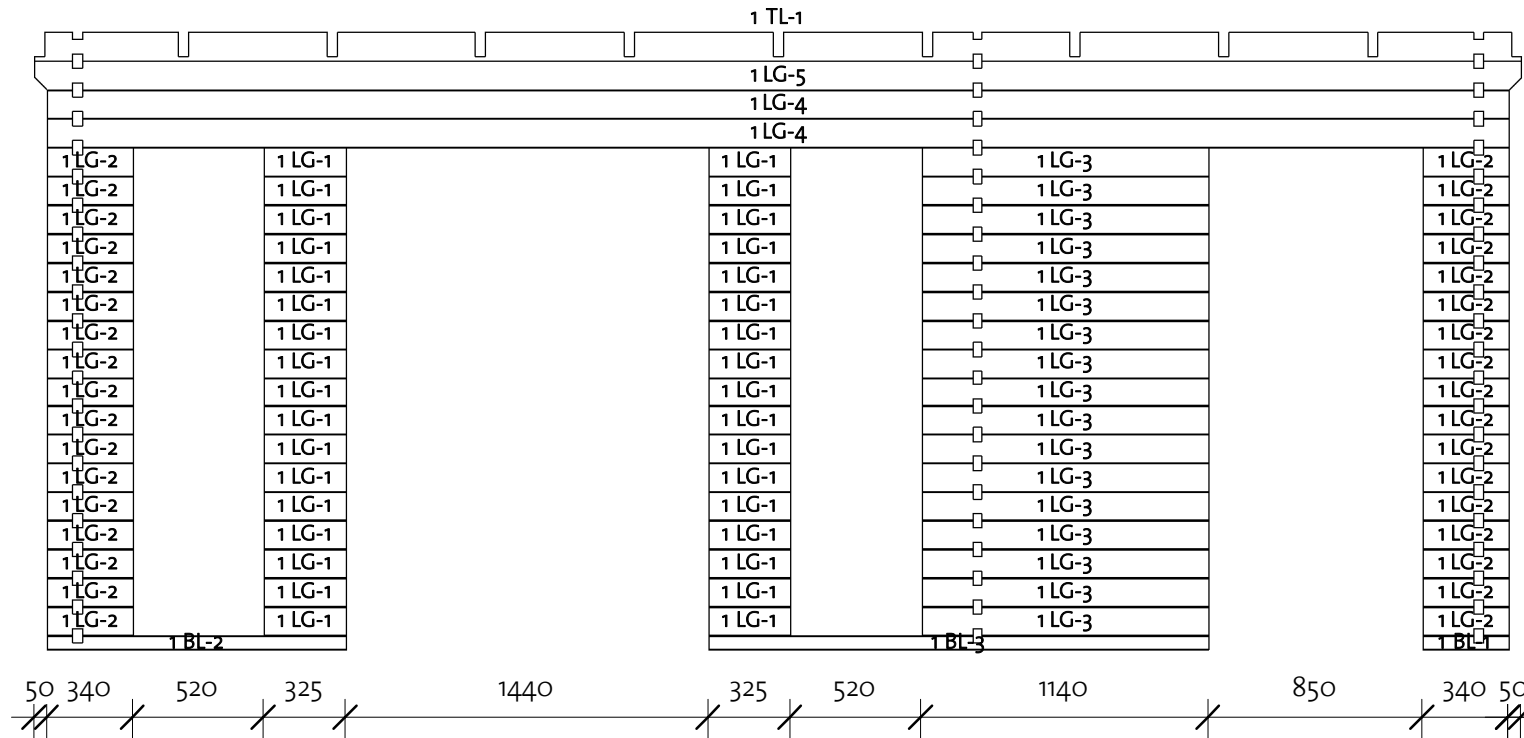

Meribel 40 (560x355)

Wall 2

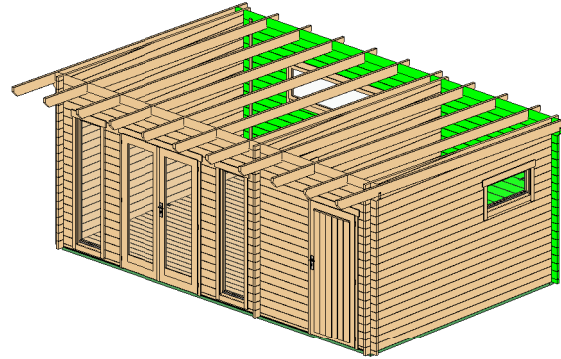

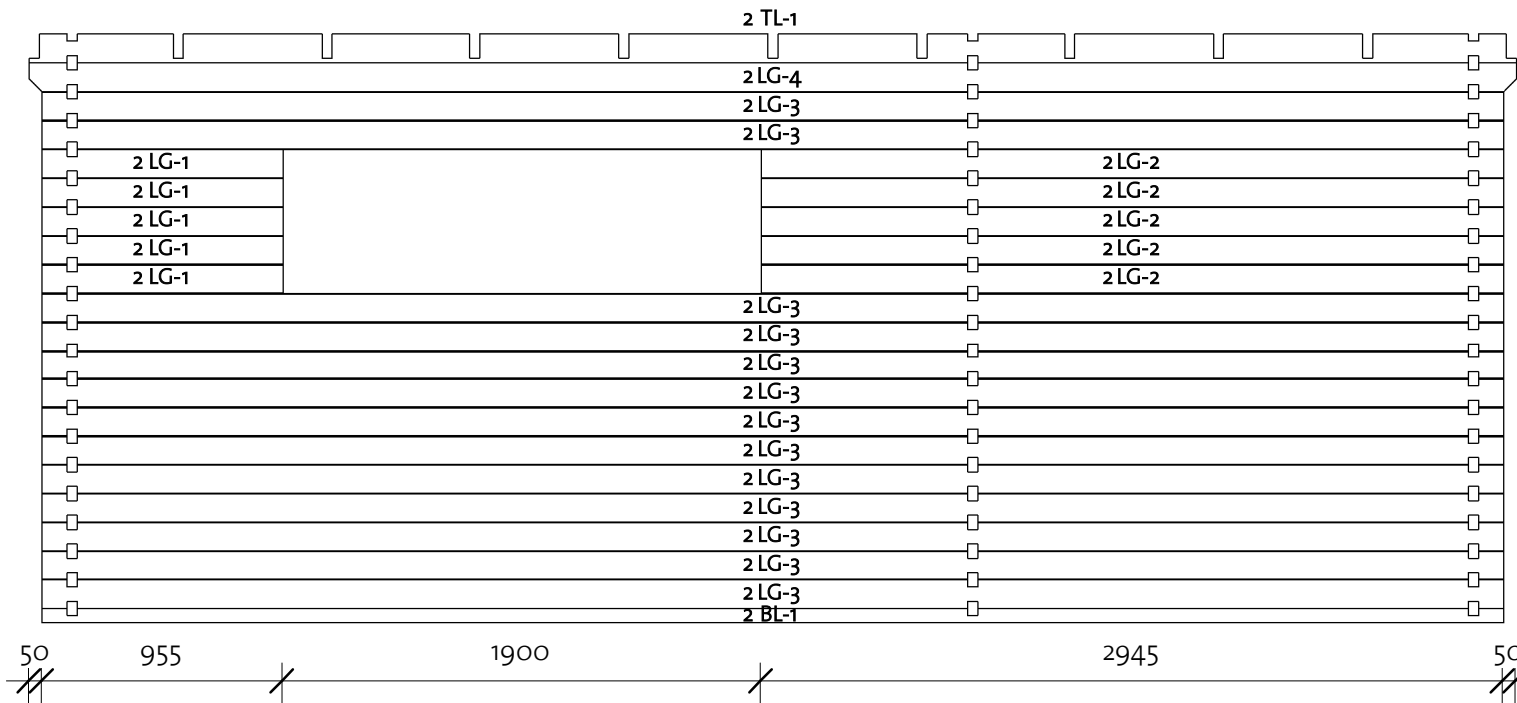

Wall 2			
Mark	Profile	Count	Cut Length

2BL-1	40x57	1	5800
2LG-1	40x114	5	955
2LG-2	40x114	5	2945
2LG-3	40x114	13	5800
2LG-4	40x114	1	5900
2TL-1	40x114	1	5900



Log Profile Wall 2	
Profile	Profile

40x57	
40x114	
40x114	

Meribel 40 (560x355)

Wall A

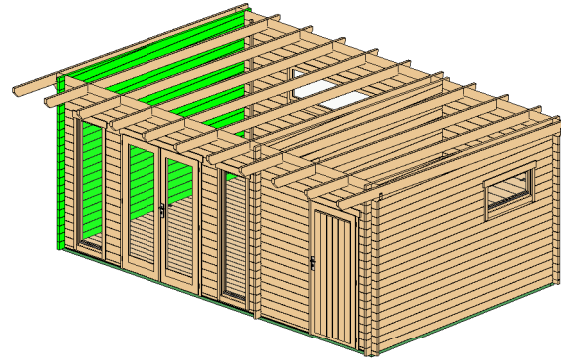

Wall A			
Mark	Profile	Count	Cut Length

ALG-1*	40x114	1	1855
ALG-2*	40x114	1	3750
ALG-3	40x114	20	3750

* Gable - delivered premounted

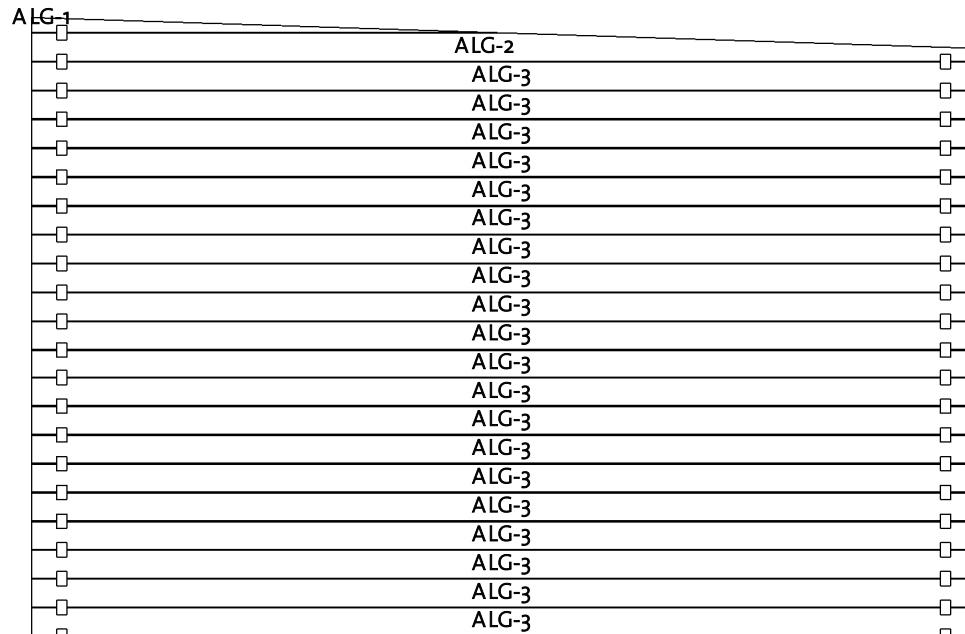

Log Profile Wall A	
Profile	Profile

40x114	
--------	--

Meribel 40 (560x355)

Wall B

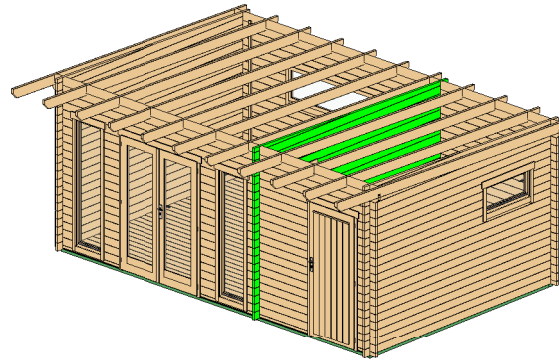

Wall B			
Mark	Profile	Count	Cut Length

BLG-1*	40X114	1	1855
BLG-2*	40X114	1	3750
BLG-3	40X114	17	2585
BLG-4	40X114	3	3750
BLG-5	40X114	17	315

* Gable - delivered premounted

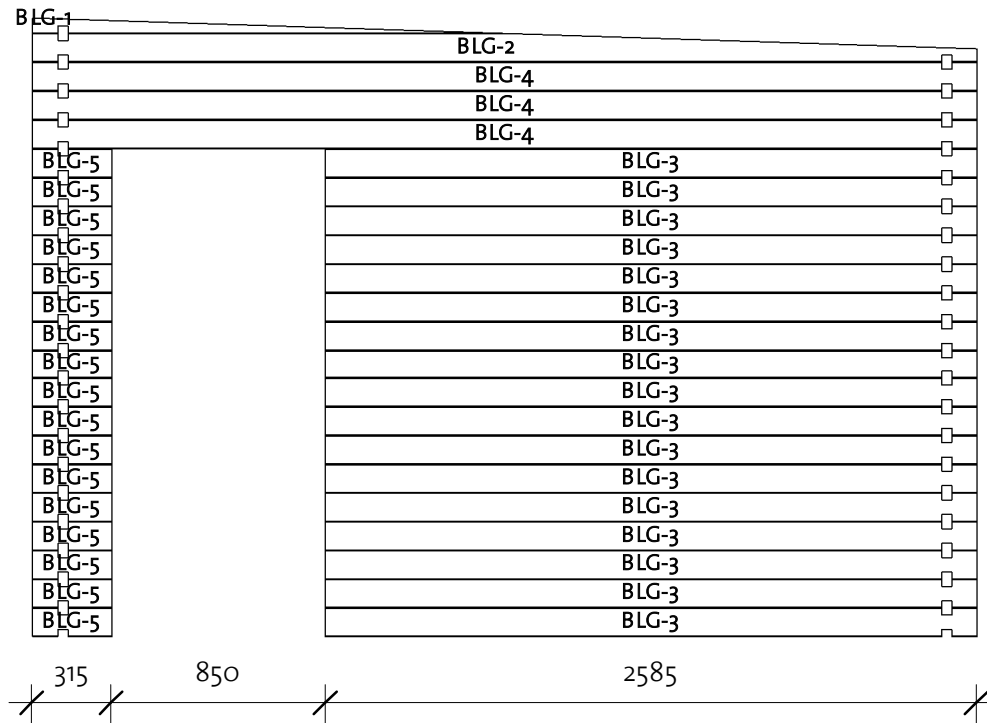

Log Profile Wall B	
Profile	Profile

40X114	
--------	--

Meribel 40 (560x355)

Wall C

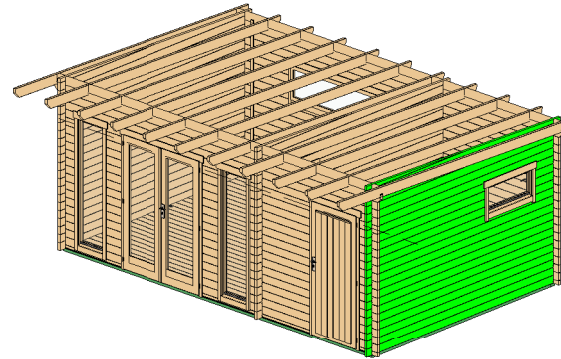

Wall C			
Mark	Profile	Count	Cut Length

CLG-1*	40X114	1	1855
CLG-2*	40X114	1	3750
CLG-3	40X114	4	2310
CLG-4	40X114	16	3750
CLG-5	40X114	4	520

* Gable - delivered premounted

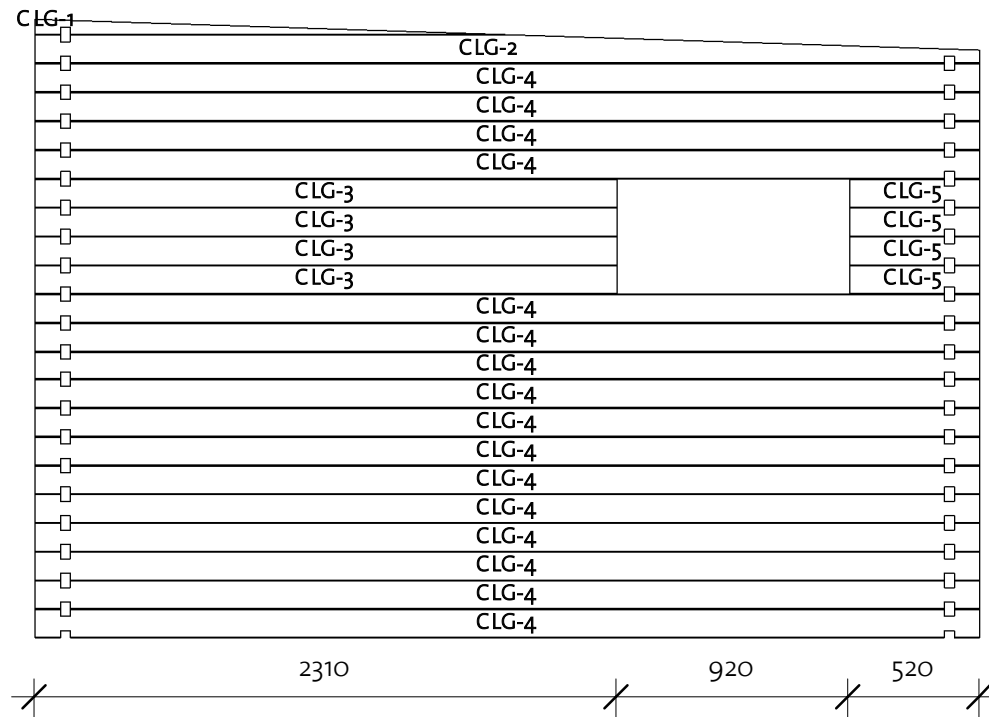



Log Profile Wall C	
Profile	Profile

40X114	
--------	---

Meribel 40 (560x355)

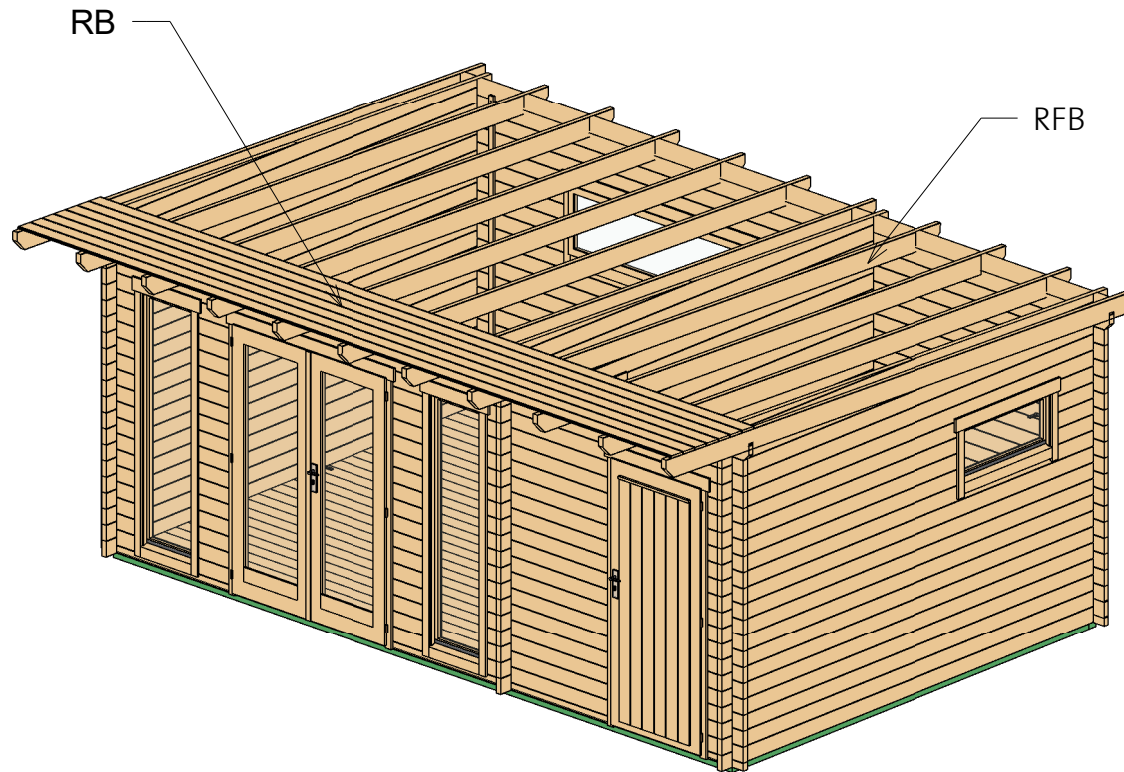
Roof 1



Roof				
Mark	Type	Profile	Count	Length
RB	17x114		41	5900
RFB	Beam 40x143		11	4552

Meribel 40 (560x355)

Roof 2

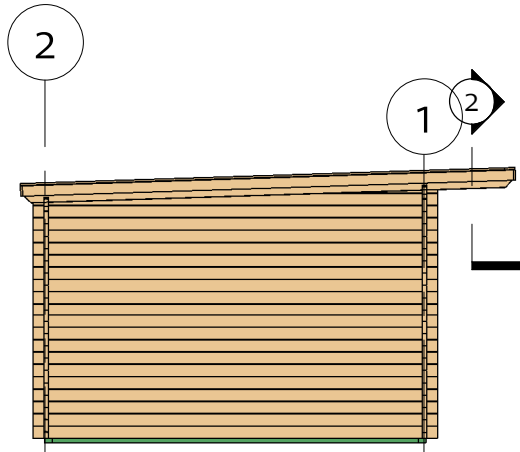

② Roof Reinforcement 1

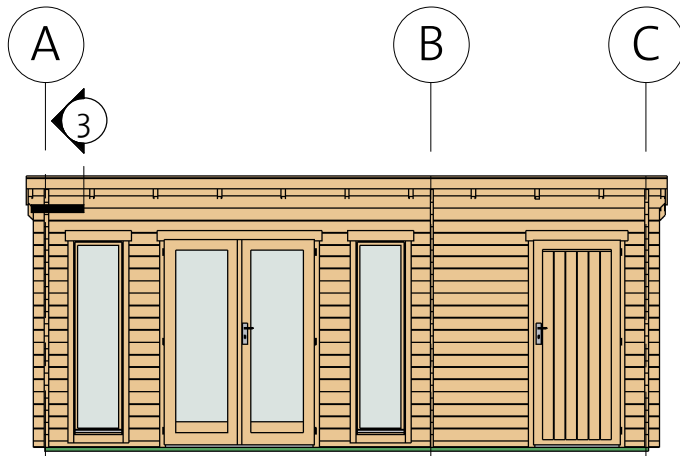
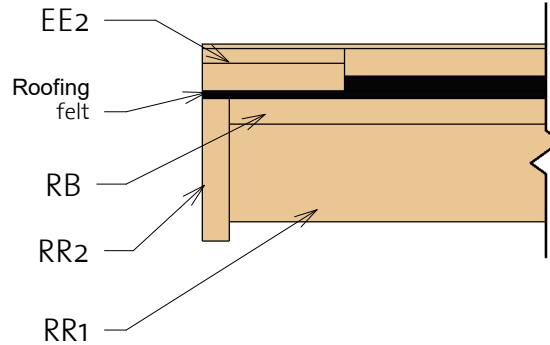

③ Roof Reinforcement 2

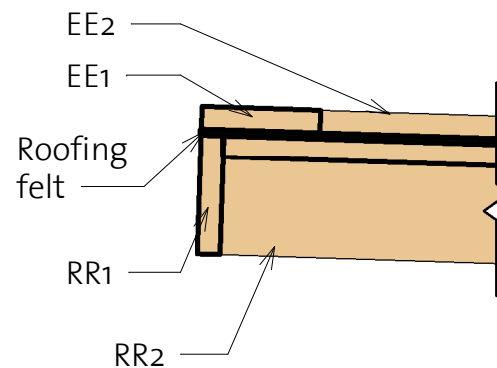

Fascia Schedule

Mark	Type	Profile	Count	Length
EE1	Eave Edging 18x95		1	5936
EE2	Eave Edging 18x95		2	4492
RR1	Roof reinforcement 18x120		2	5936
RR2	Roof reinforcement 18x120		2	4551

Meribel 40 (560x355)

Extras

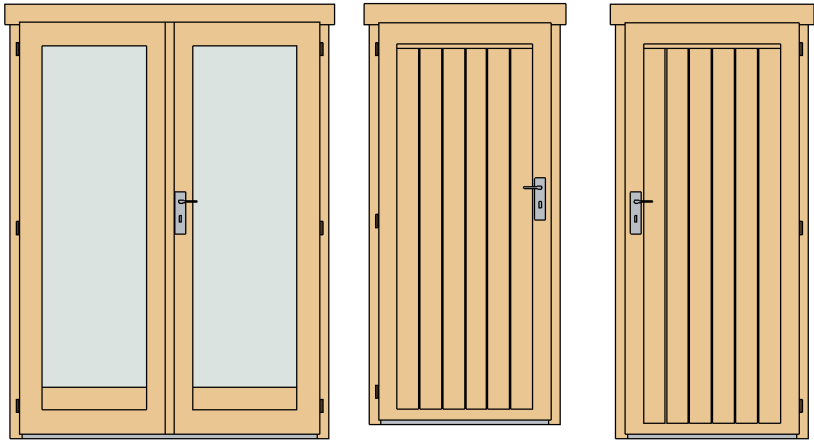

Door Schedule				
Model	Type	Width	Height	Count

CDD3R	Classic double door 3, full glass right	1425	1955	1
CD5L	Classic door 5, wood left	840	1890	1
CD7R	Classic door 7, wood right	840	1955	1

DB	Door beam 850 mm	40	12	1
----	------------------	----	----	---

Window Schedule				
Mark	Type	Width	Height	Count

CW3R	Classic window 3, full glass right	515	1890	2
CW7R	Classic window 7, full glass right	915	420	1
CW11R	Classic window 11, full glass right	1890	530	1

Fasteners/Extras		
Name	Type	Count

Hitblock	300-400 mm	
Bolts	M8 x 70	12
Screws	5,0 x 70	30
Nails	1,4 x 40	65
Screws	6,0 x 140	95
Screws	4,0 x 40	125
Screws	4,0 x 50	1000

Type	Count	Length
------	-------	--------

Windboard 18x40	4	2400
-----------------	---	------

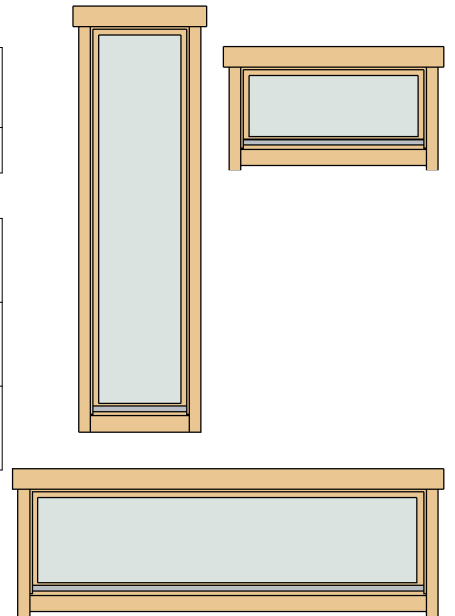

92105142_210526



Meribel 40 (560x355)

List of all items 1



Impregnated foundation beams				
Mark	Type	Profile	Count	Length

IFB1	IFB 70x40		2	5590
IFB2	IFB 70x40		11	3400





Roof				
Mark	Type	Profile	Count	Length

RB	17x114		41	5900
RFB	Beam 40x143		11	4552

Floor Schedule				
Mark	Type	Profile	Count	Length

FB1	FB 17x114		32	3524
FB2	FB 17x114		32	1944
BB1	BB 20x40		4	3600
BB2	BB 20x40		2	5600

Fascia Schedule				
Mark	Type	Profile	Count	Length

EE1	Eave Edging 18x95		1	5936
EE2	Eave Edging 18x95		2	4492
RR1	Roof reinforce ment 18x120		2	5936
RR2	Roof reinforce ment 18x120		2	4551

Meribel 40 (560x355)

List of all items 2

Wall 1			
Mark	Profile	Count	Cut Length

1BL-1	40x57	1	340
1BL-2	40x57	1	1185
1BL-3	40x57	1	1985
1LG-1	40x114	34	325
1LG-2	40x114	34	340
1LG-3	40x114	17	1140
1LG-4	40x114	2	5800
1LG-5	40x114	1	5900
1TL-1	40x114	1	5900

Wall 2			
Mark	Profile	Count	Cut Length

2BL-1	40x57	1	5800
2LG-1	40x114	5	955
2LG-2	40x114	5	2945
2LG-3	40x114	13	5800
2LG-4	40x114	1	5900
2TL-1	40x114	1	5900

* Gable - delivered premounted

Log profiles	
Profile	Profile

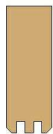
40x57	
40x114	

Wall A			
Mark	Profile	Count	Cut Length

ALG-1*	40x114	1	1855
ALG-2*	40x114	1	3750
ALG-3	40x114	20	3750

Wall B			
Mark	Profile	Count	Cut Length

BLG-1*	40x114	1	1855
BLG-2*	40x114	1	3750
BLG-3	40x114	17	2585
BLG-4	40x114	3	3750
BLG-5	40x114	17	315

Wall C			
Mark	Profile	Count	Cut Length

CLG-1*	40x114	1	1855
CLG-2*	40x114	1	3750
CLG-3	40x114	4	2310
CLG-4	40x114	16	3750
CLG-5	40x114	4	520

Log profiles	
Profile	Profile

40x114	
--------	---