

Art. Nr. 2833996

1/6



22/10/2023





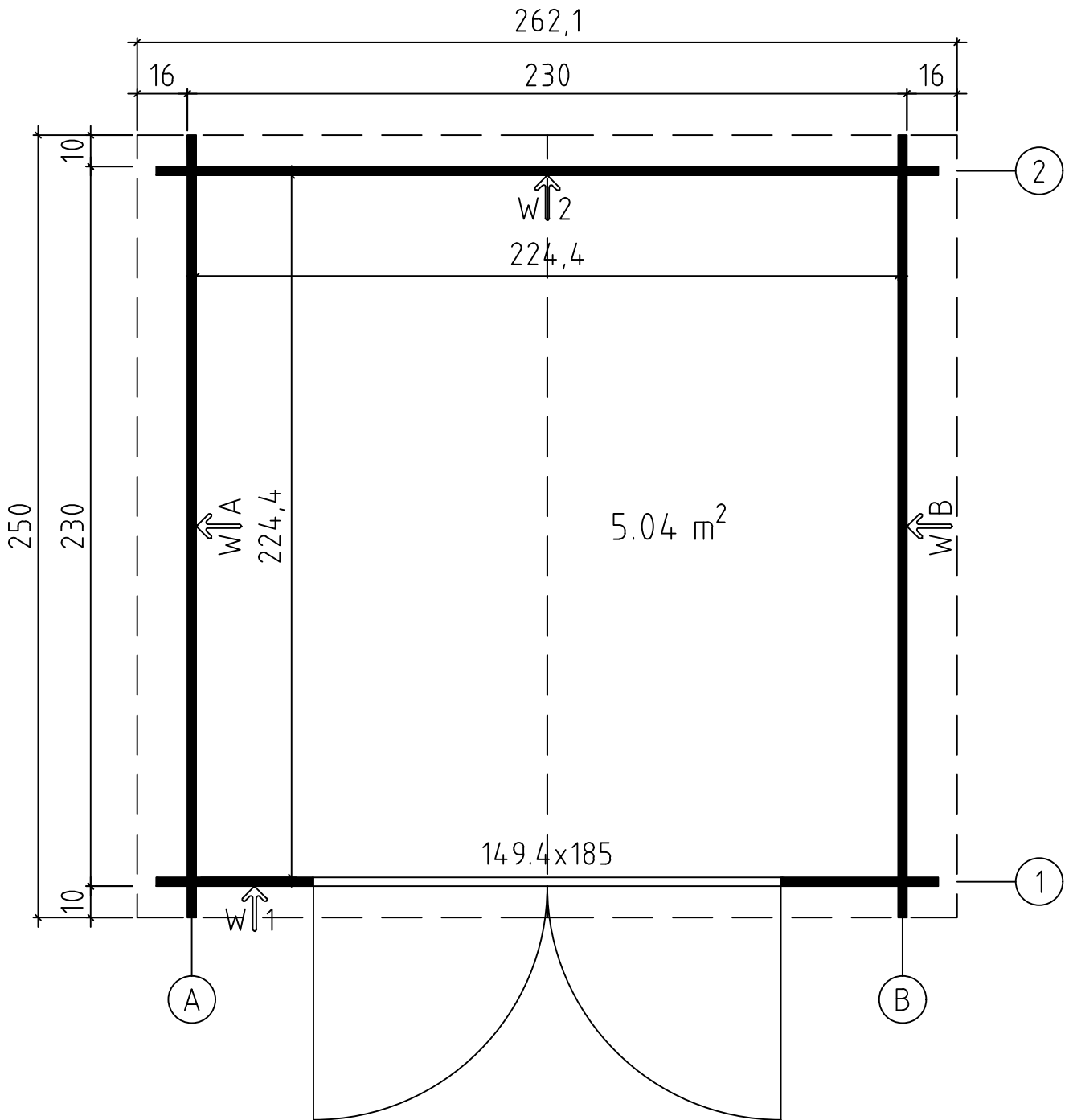

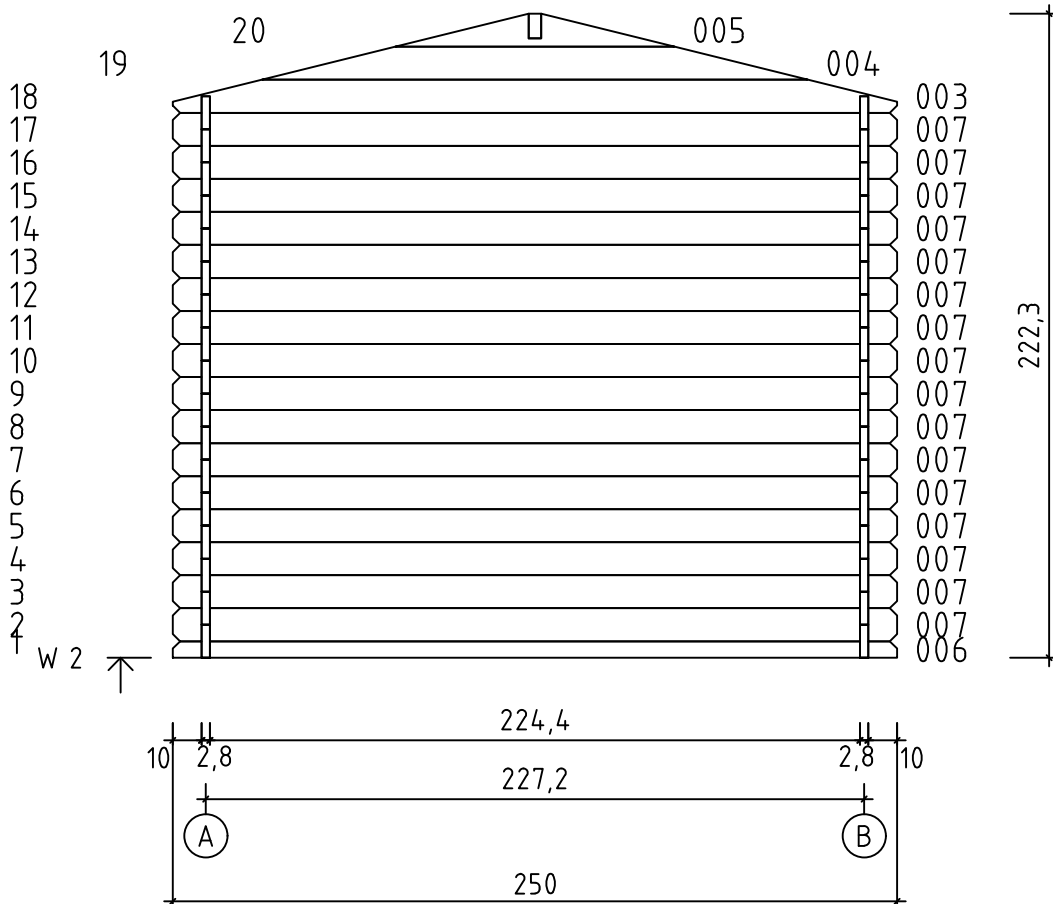
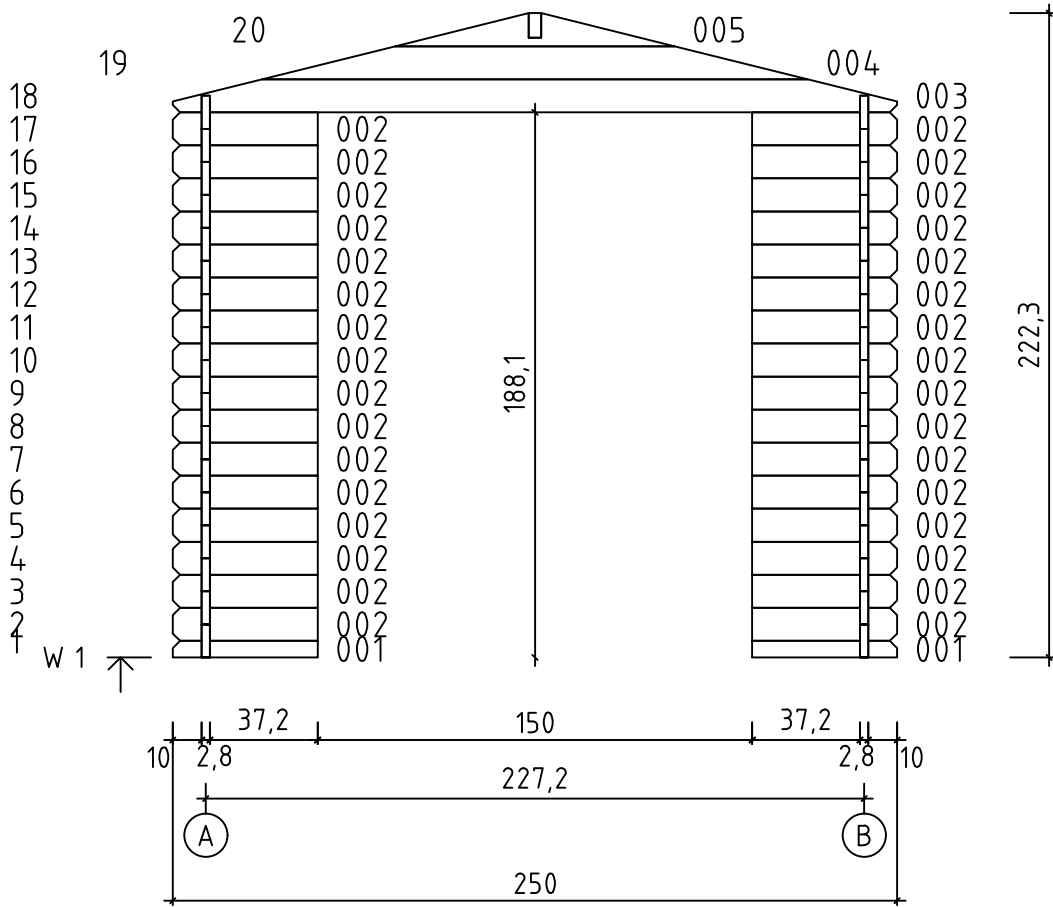

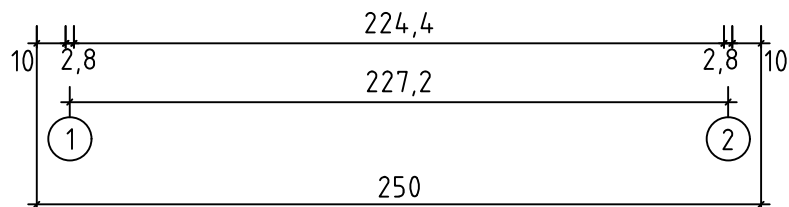
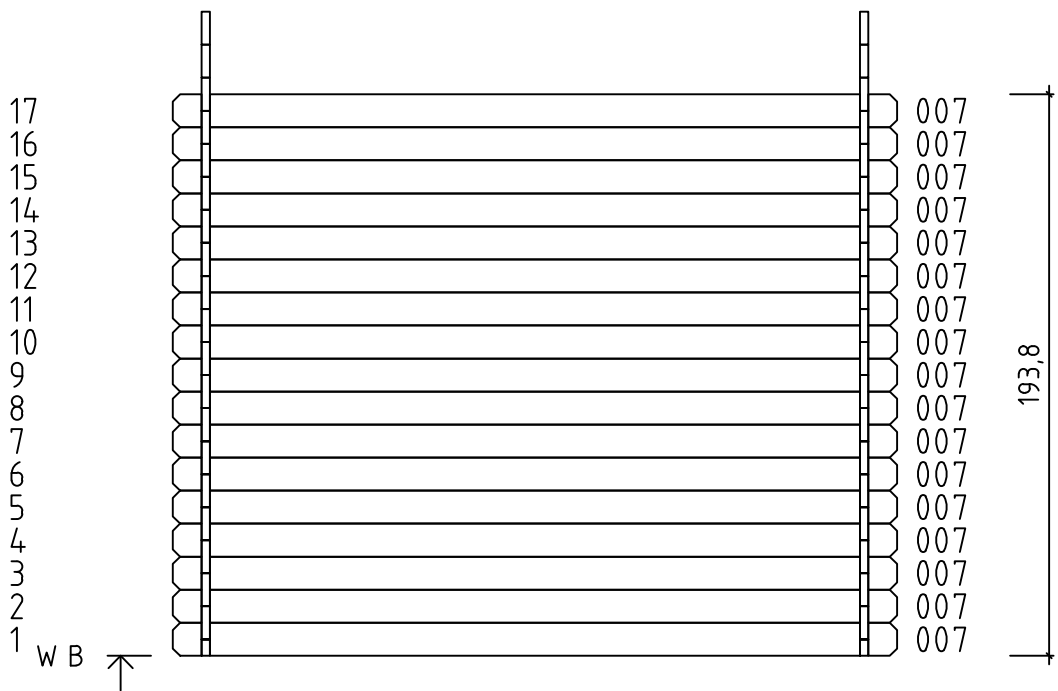
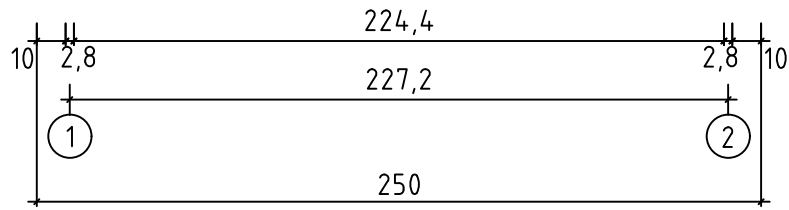
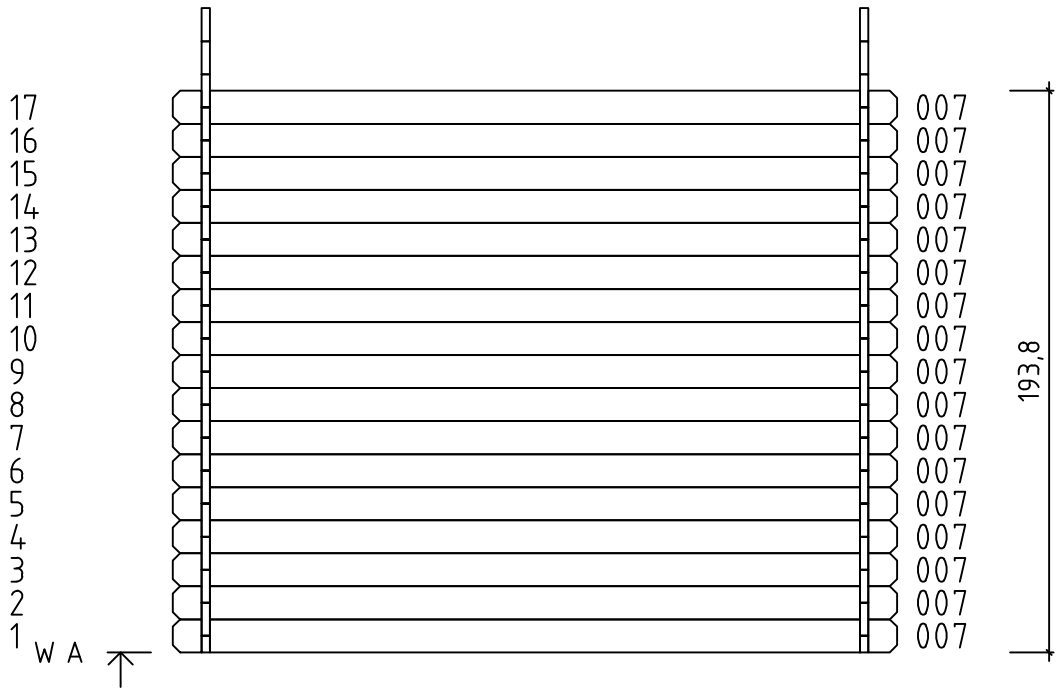

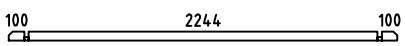
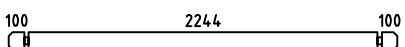
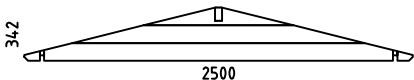
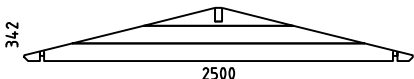
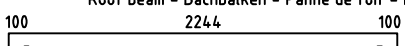
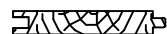
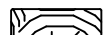
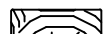
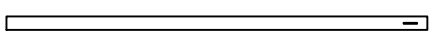
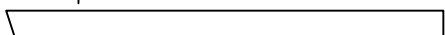
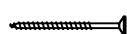

Art.Nr. 2833996

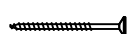



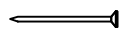
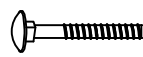

Groundplan - Grundplan - Plan de masse
Planimetria - Plattegrond - Põhiplaan



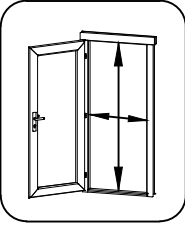
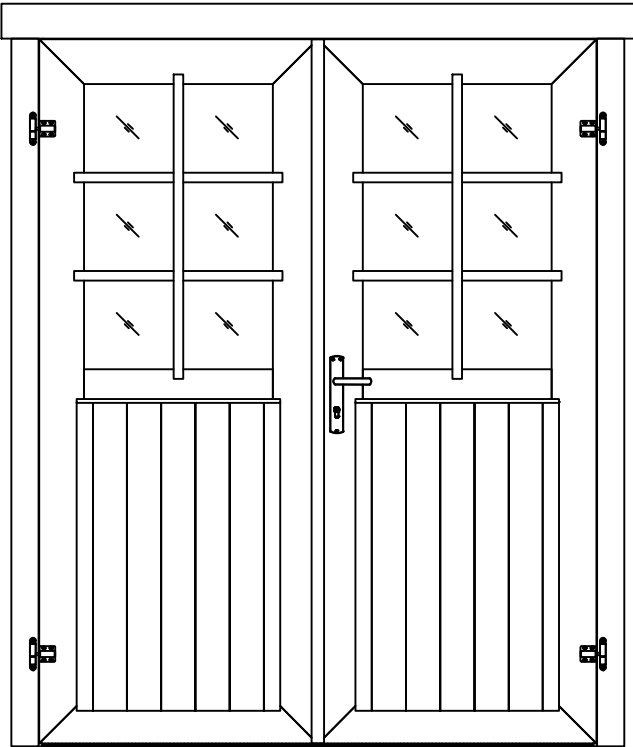

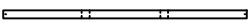
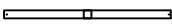

| Pos | 22.10.2023 Piece list - Stückliste - Liste des pièces - Elementi - Stuklijst - Joonis Art.Nr. 2833996 | 5/6 | Q | P (mm) | L (mm) |
|----------------|---|-----|-----|-----------|-----------|
| 001 1157 |  | | 2 | 28x57 | 500 |
| 002 1220 |  | | 32 | 28x114 | 500 |
| 006 928 |  | | 1 | 28x57 | 2500 |
| 007 929 |  | | 50 | 28x114 | 2500 |
| W1-1 35423 |  | | 1 | | |
| W2-1 35423 |  | | 1 | | |
| A-PR1 33306 | Roof beam - Dachbalken - Panne de toit - Perlina del tetto - Gordingen / dakbalk - Abipärliinid  | | 1 | 44x120 | 2500 |
| 938 | Roof boards - Dachbretter - Voliges - Perlina per tetto - Dakhout - Katuselaud  | | 56 | 90x15.5 | 1350 |
| 27940 | Roofing felt fillet - Dachpappenleiste - Baguette de fixation du feutre bitumeux - Asse per fissaggio guaina bituminosa - Afdekljst asfaltpapier - Katusepapiilist  | | 4 | 15x45 | 1400 |
| DRV-1 27998 | Roof edge reinforcement - Dachrandverstärkung - Corniere de renfort de bord de toit - Rinforzo x tetto - Dakrand versterking - Räästatugevdus  | | 2 | 15x45 | 2500 |
| KFS-1 2249 | Storm protection - Sturmleiste - Latte anti-tempete - Protezione anti vento - Stormverankering / beveliging - Tormikinnitus  | | 4 | 22x45 | 2050 |
| 27942 | Gable moulding - Giebelleiste - Planche de rive - Finitura per frontale e retro del tetto - Gevellijst - Viilulaud  | | 4 | 15x120 | 1400 |
| HS8 5105 | Screw for gable segment - Schrauben für deckblatt - Vis pour fixation losange de finition - Viti x frontali tetto - Schroef voor gevelpunt segment - Kruvi rombile  | | 4 | 3.5x35 | |
| HS8 5106 | Screw for gable moulding - Schrauben für giebelleiste - Vis pour fixation planche de rive - Vite per fissare finiture davanti e dietro del tetto - Schroef voor gevellijst - Kruvi viilulauale  | | 16 | 3.5x50 | |
| HS4 5102 | Screw for roof edge reinforcement - Schrauben für dachrandverstärkung - Vis pour fixation corniere renfort de bord de toit - Viti x rinforzo bordo tetto - Schroef voor dakrand versterking - Kruvi räästatugevdusele  | | 12 | 3x30 | |
| HS18 5113 | Screw for roof beams - Schrauben für dachbalken - Vis pour fixation pannes de toit - Viti per perline del tetto - Schroef voor gordingen / dakbalken - Kruvi pärlinitele  | | 2 | 5x120 | |
| HS18 5113 | Screw for gable - Schrauben für giebel - Vis pour fixation des pignons - Viti per timpano - Schroef voor gevelpunt - Kruvi viilude kinnitamiseks  | | 4 | 5x120 | |
| SH28 32509 | Hammer block - Schlagholz - Calle de frappe - Blocco di legno da usare come cuscinetto quando si usa il martello - Slagklos - Löögiklots  | | 1 | | |
| SFS 5133 | Nut for storm protection - Schraubenmutter für sturmleiste - Erou pour latte anti-tempete - Dado x asta protezione vento - Moer voor stormverankering - Mutter tormikinnitusele  | | 8 | D6 | |
| NF4 | Zn nail for roof - Zn nägel für dachbretter - Pointe pour fixation voliges de toit - Chiodi x perline tetto - Spijker(nagel) voor dakhout - Nael katuselauale  | | 120 | 2x50 | |
| NF5 | Zn nail for roofing felt fillet - Zn nägel für dachpappenleiste - Pointe pour baguette de fixation feutre bitumeux - Chiodi x carta bituminosa x tetto - Spijker(nagel) voor asfaltpapier afdekljst - Papiilistunael  | | 16 | 2x40 | |
| BFS | Bolt for storm protection - Bolzen für sturmleiste - Boulon pour latte anti-tempete - Bullone x asta protezione vento - Bout voor stormankertlat - Puidupolt tormikinnitusele  | | 8 | 6x60 | |
| GS | Gable segment - Deckblatt - Losange de finition - Decorazione in legno x frontale tetto - Gevelpunt segment - Romb  | | 2 | | |

| Pos | 19.12.2017 | Piece list - Stückliste - Liste des pièces - Elementi - Stuklijst - Tükítabel 14 94x1850 TUK.2.056.SVP.MMX28 SGA+28 | 1/2 | Q | P (mm) | L (mm) |
|--|---|--|---|---|-----------|-----------|
| Glass size - Glasgröße - Taille de la vitre - Misura del vetro - Glas afmeting - Klaasi mõõt: 502x750 mm | | | |  <p>1418x1794 mm</p> | | |
|  | | | | | | |
| 1 | Upper door jamb - Türrahmen oben - Cadre de porte supérieur - Telaio superiore della porta - Bovendorpel - Ukse ülemine leng | |  | 1 | 66x100 | 1628 |
| 2 | Left door jamb - Türrahmen links - Cadre de porte gauche - Telaio montante sinistro della porta - Linkerstijl deurframe - Ukse vasak leng | |  | 1 | 66x80 | 1850 |
| 3 | Right door jamb - Türrahmen rechts - Cadre de porte droit - Telaio montante destro della porta - Rechterstijl deurframe - Ukse parem leng | |  | 1 | 66x80 | 1850 |
| 4 | Doorstep - Swelle - Barre de seuil - Soglia della porta - Deurdorpel - Lävepakk | |  | 1 | 20x21 | 1418 |
| 5 | Connection strip - Deckleiste - Baguette de battement - Profilo verticale della porta - Stulplijst - Kokkuvältsiliist | |  | 1 | 13x32 | 1812 |
| 6 | Georgian bars - Sprossen - Croisillons - La griglia georgiana - Raamverdeling - Petteliistud | |  | 2 | 15x25 | 784 |
| 7 | Georgian bars - Sprossen - Croisillons - La griglia georgiana - Raamverdeling - Petteliistud | |  | 4 | 15x25 | 536 |

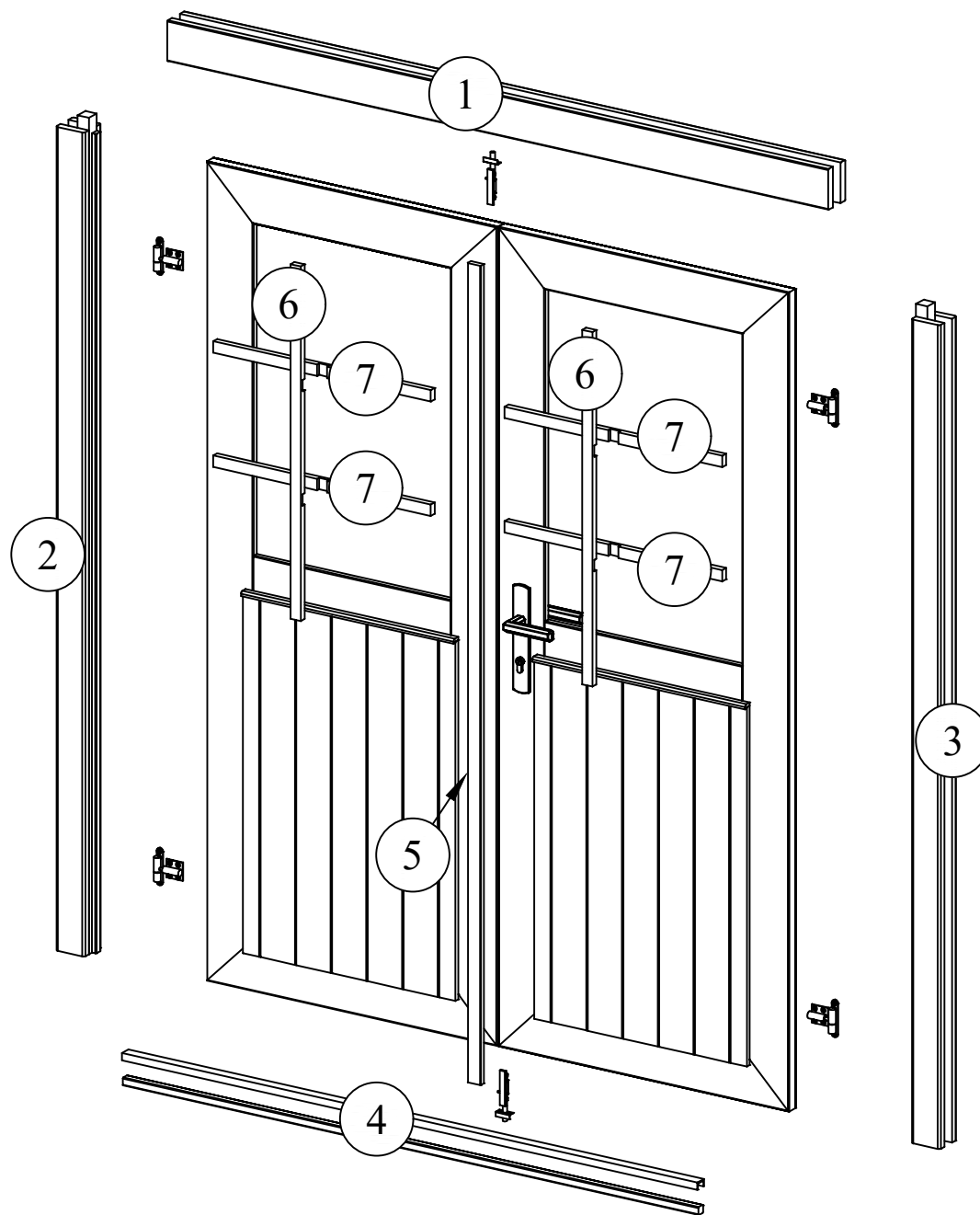

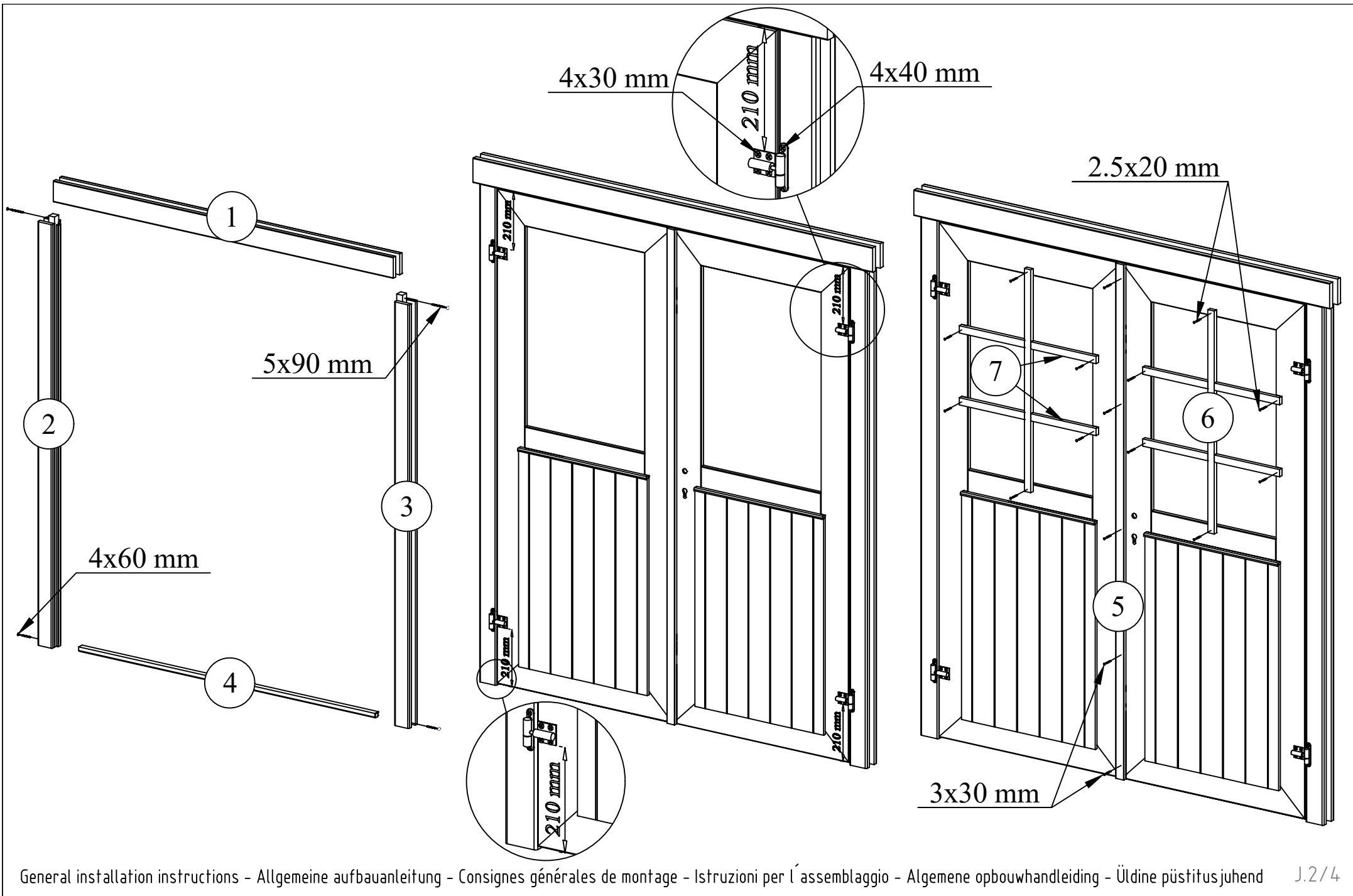

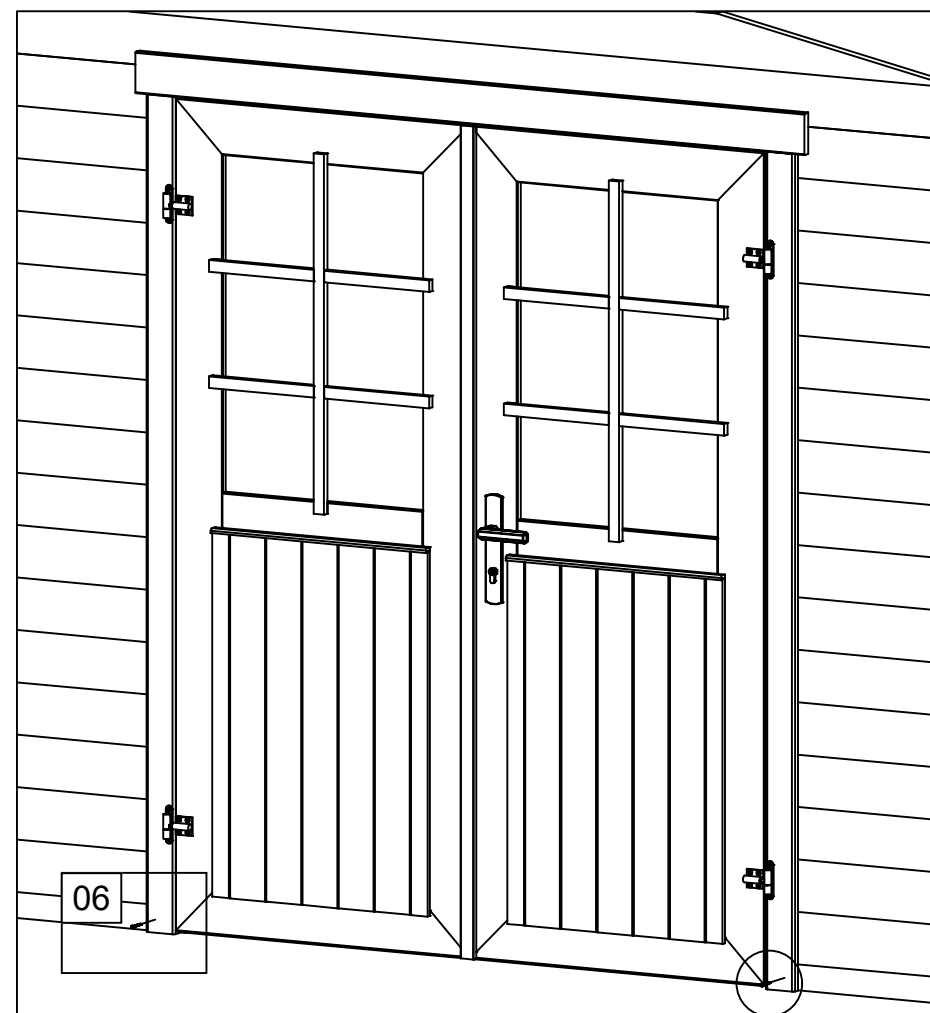
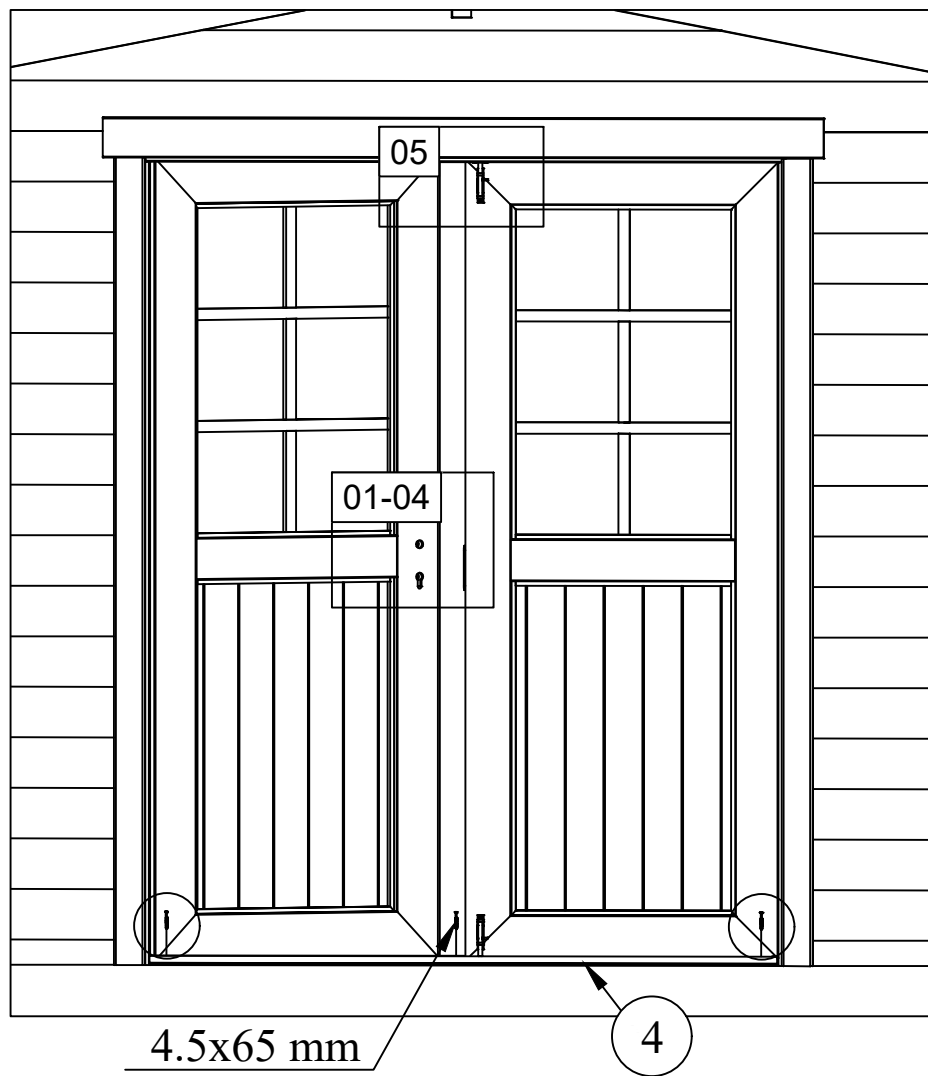

01



04



02



05



03



06

