

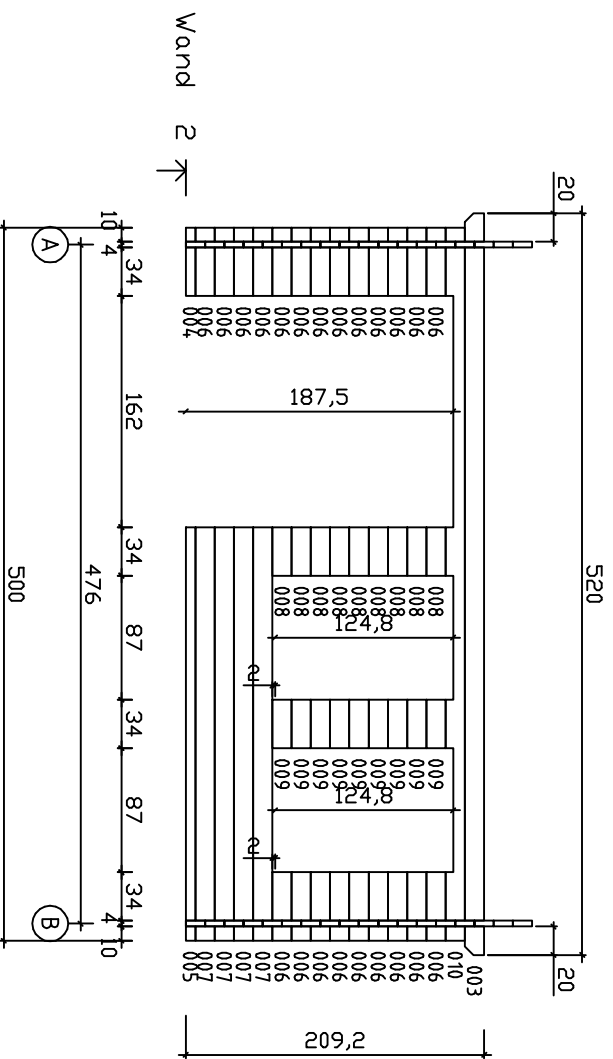

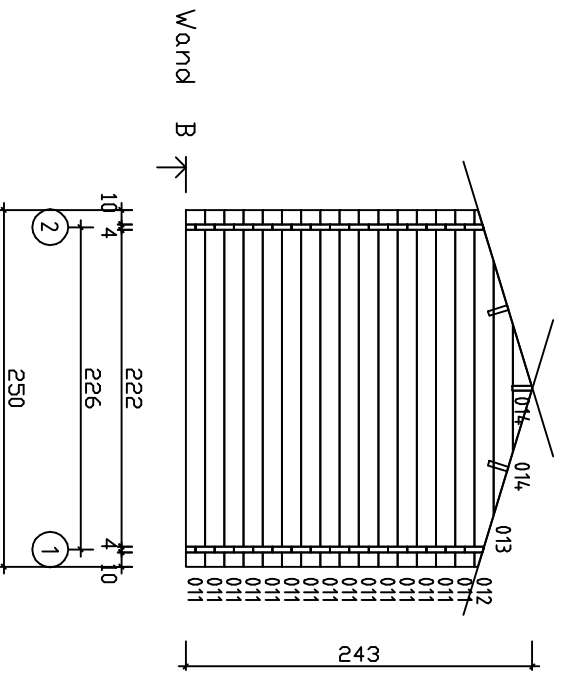

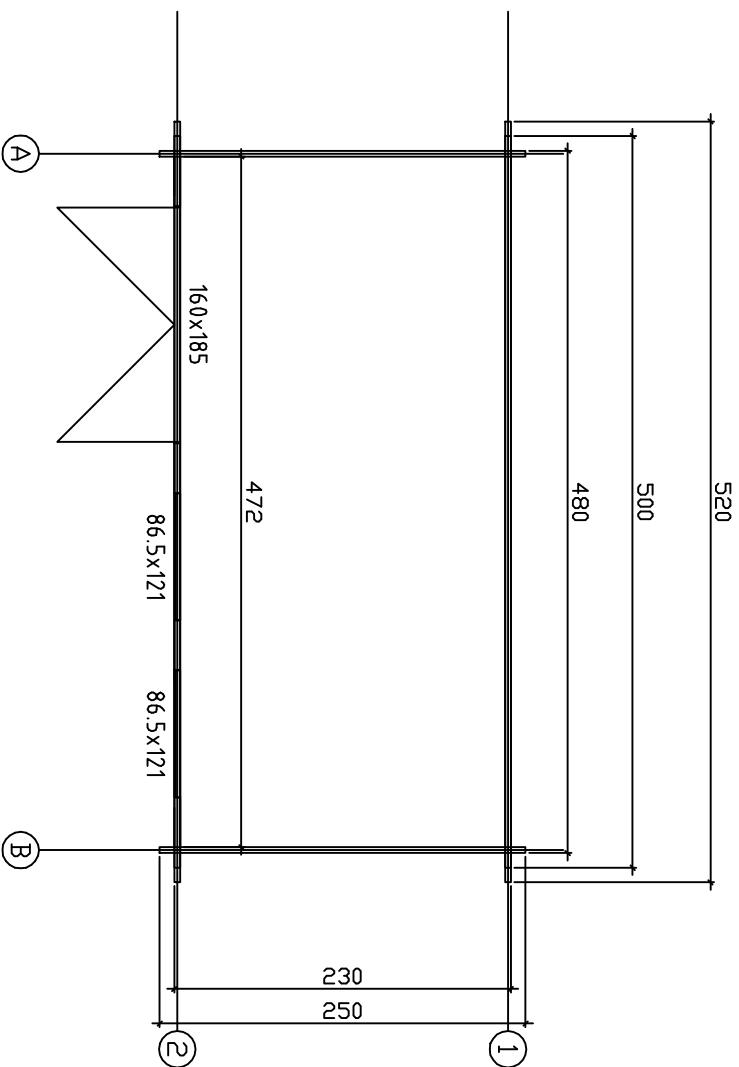



Kood	Justine	Leht	2
Joonis	Wand A	Mootkava	1:50
Materjal	4,0x13,5	Kuup.	03.05.2016
Joonestaj	File Justine.dwg		

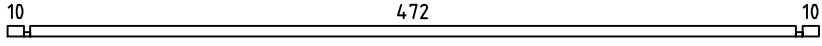
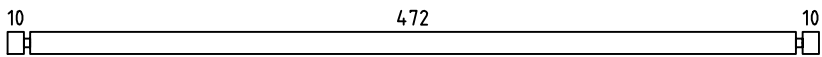
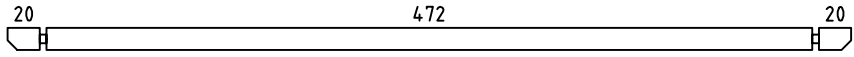

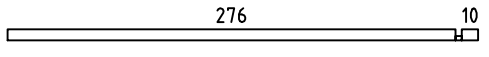

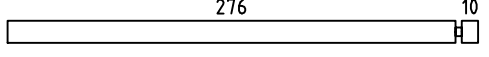

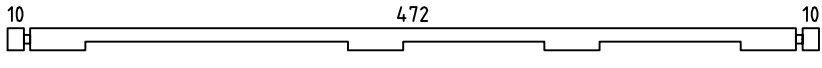
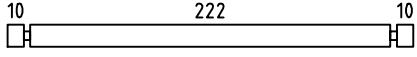
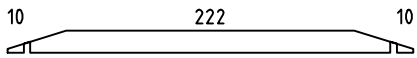
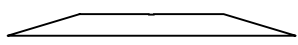

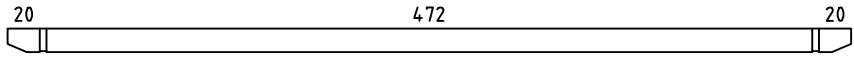
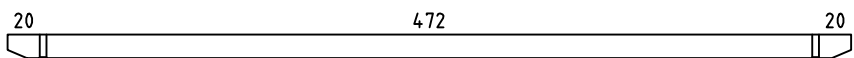
Kood	Justine	Leht 5
Joonis	Wand 2	Mootkava, 1:50
Materjal	4,0x13,5	Kuup, 03.05.2016
Joonestias	File	Justine.dwg

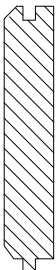

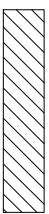
Kood	Justine	Leht	
Joonis		Mootkava	1:50
Mä terjal	4,0 × 13,5	Kuup.	03.05.2016
Joonestas		File	Justine.dwg

Pos	Drawing Justine	Pcs	Profile (cm)	Length (cm)
001		1	4x6.8	500
002		14	4x13.5	500
003		2	4x13.5	520
004		1	4x6.8	48
005		1	4x6.8	290
006		22	4x13.5	48
007		4	4x13.5	290
008		9	4x13.5	34
009		9	4x13.5	34
010		1	4x13.5	500
011		30	4x13.5	250
012		2	4x13.5	250
013		2	4x13.5	177.6
014		4	4x13	42.7
PR1		2	4.3x14.5	520
PR2		1	4.3x14.5	520
	WINDOW 86.5x121	2		
	DOOR 160x185	1		
Kood Justine		Materjal		File Justine.dwg
				Leht 1/2

Pos	Drawing Justine	Pcs	Profile (cm)	Length (cm)
018	ROOF BOARDS/DACHBRETTER/VOLIGE 	94 77	11.2x1.6 13.7x1.6	155 155
019	ROOF EDGE REINFORCEMENT / TRAUFFENLEISTE / TASSEAU 	2	2.6x3.2	520
020	ROOF SIDE BOARDS / TRAUFFENBRETT / PLANCHE DE RIVE 	2	1.8x6	520
021	FASCIA BOARD / GIEBELBLENDE / PLANCHE DE RIVE (FACADE) 	4	1.8x12.0	159
022	FASCIA BOARD / GIEBELBLENDE / PLANCHE DE RIVE (FACADE) 	4	1.8x6.0	159
023	DIAMOND / RAUTE / DIAMANT 	2	1.8x12	120
Kood	Justine	Materiaal	File Justine.dwg	Leht 2/2