

Vello 2 40 (250x300)

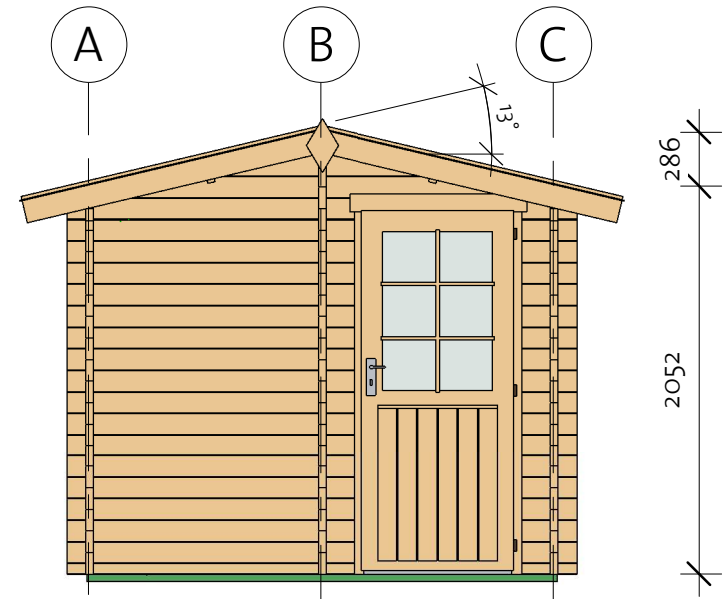

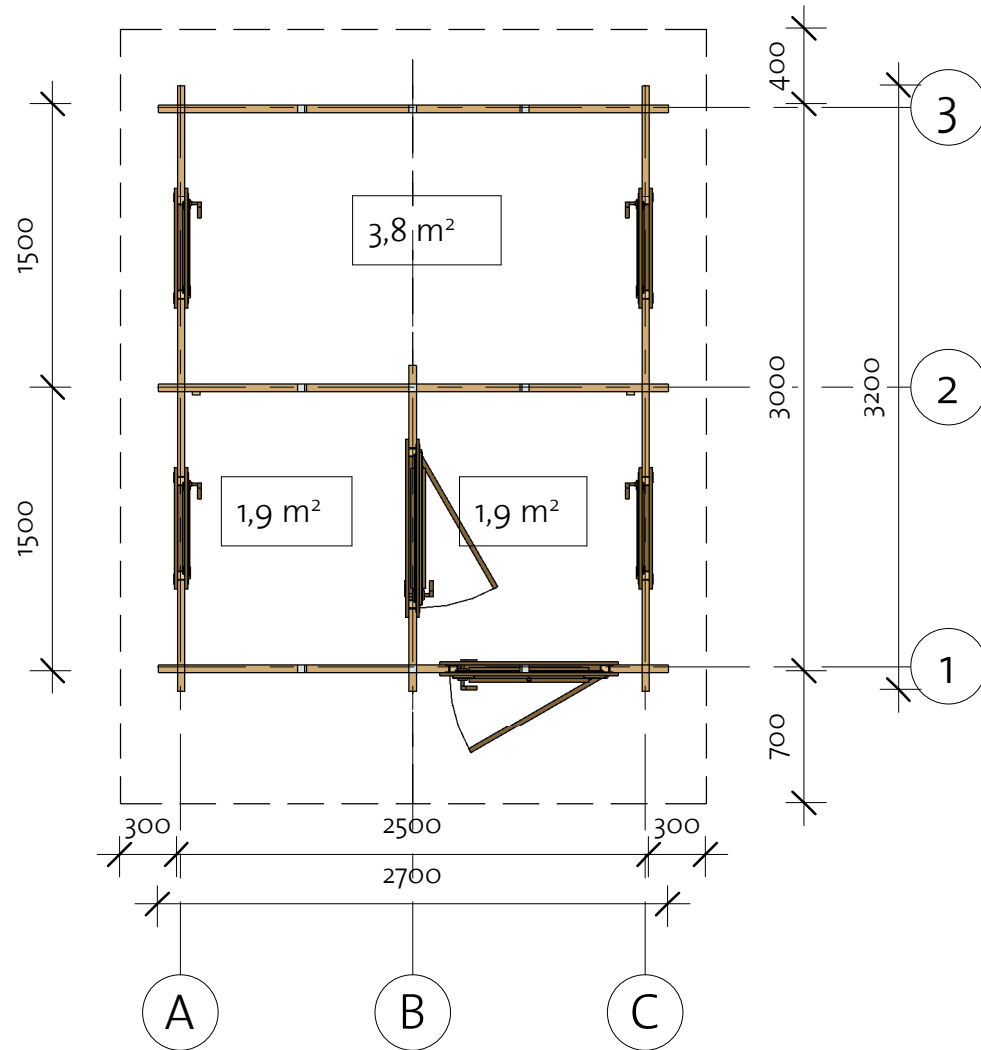
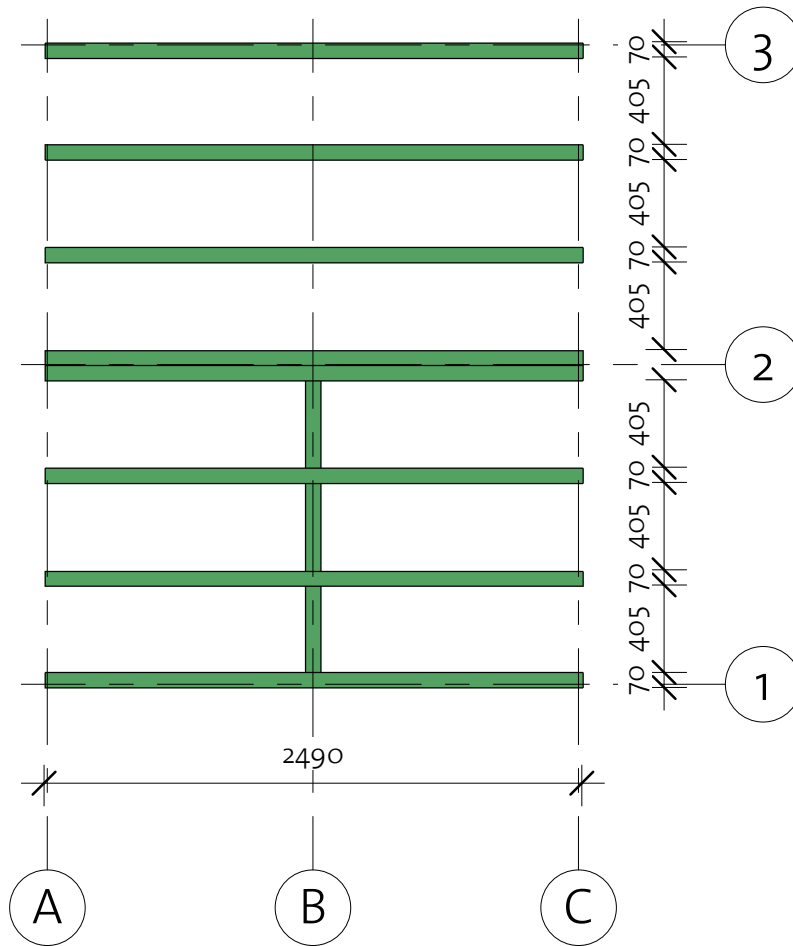

Vello 2 40 (250x300)

Foundation



Impregnated foundation beams

Mark	Type	Profile	Count	Length
------	------	---------	-------	--------

IFB1	IFB 70x40		8	2490
IFB2	IFB 70x40		3	405



Vello 2 40 (250x300)

Floor Plan

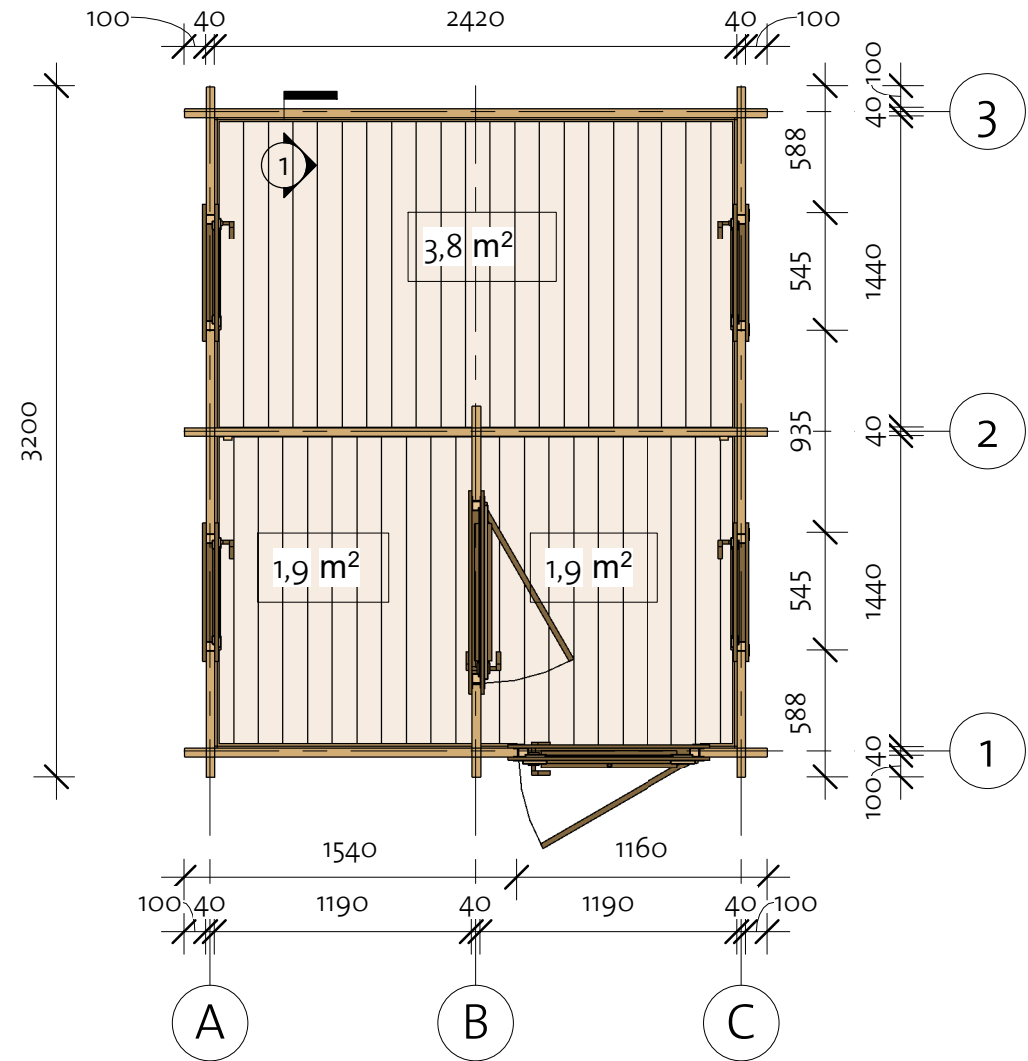
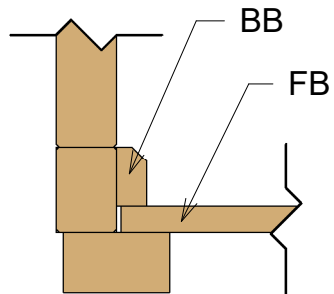
① Baseboard



Floor Schedule

Mark	Type	Profile	Count	Length
FB	FB 17x114		46	1434
BB1	BB 20x40		3	3000
BB2	BB 20x40		4	2500

Vello 2 40 (250x300)

Wall 1

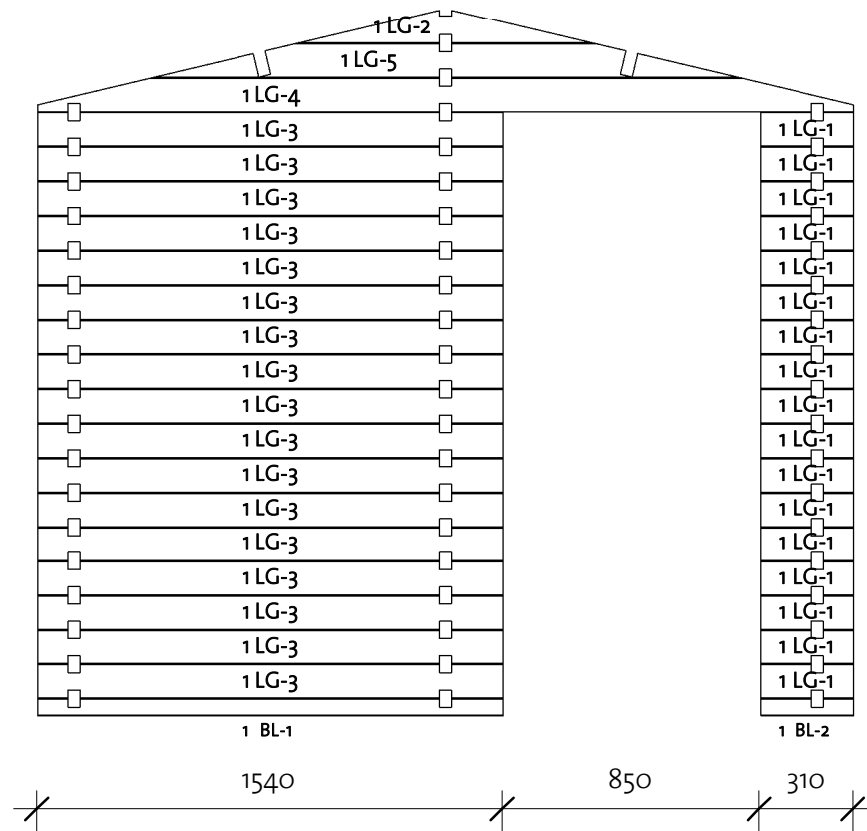
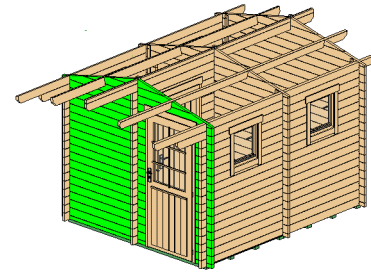

Wall 1			
Mark	Profile	Count	Cut Length

1BL-1	40X57	1	1540
1BL-2	40X57	1	310
1LG-1	40X114	17	310
1LG-2*	40X114	1	974
1LG-3	40X114	17	1540
1LG-4*	40X114	1	2700
1LG-5*	40X114	1	1938

* Gable - delivered premounted

Log Profile Wall 1	
Profile	Profile

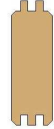
40X57	
40X114	

Vello 2 40 (250x300)

Wall 2

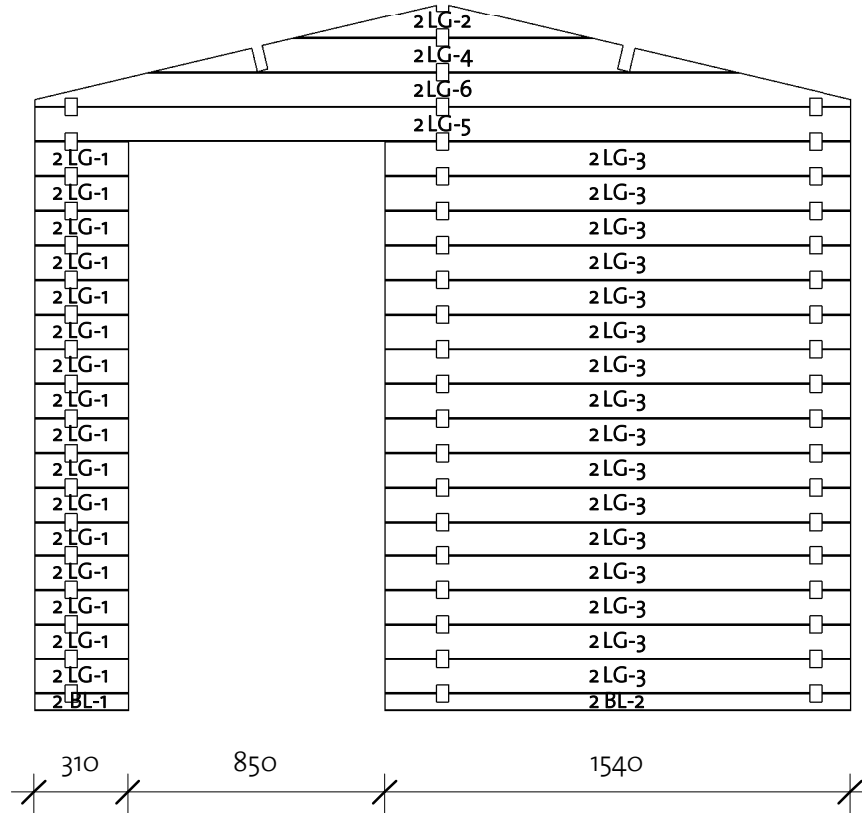
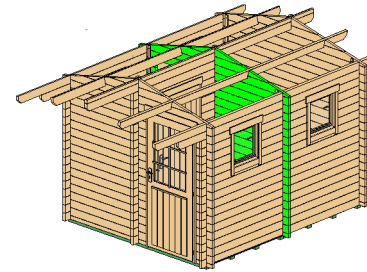

Wall 2			
Mark	Profile	Count	Cut Length

2BL-1	40x57	1	310
2BL-2	40x57	1	1540
2LG-1	40x114	16	310
2LG-2*	40x114	1	974
2LG-3	40x114	16	1540
2LG-4*	40x114	1	1938
2LG-5	40x114	1	2700
2LG-6*	40x114	1	2700

* Gable - delivered premounted

Log Profile Wall 2	
Profile	Profile

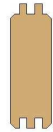
40x57	
40x114	

Vello 2 40 (250x300)

Wall 3

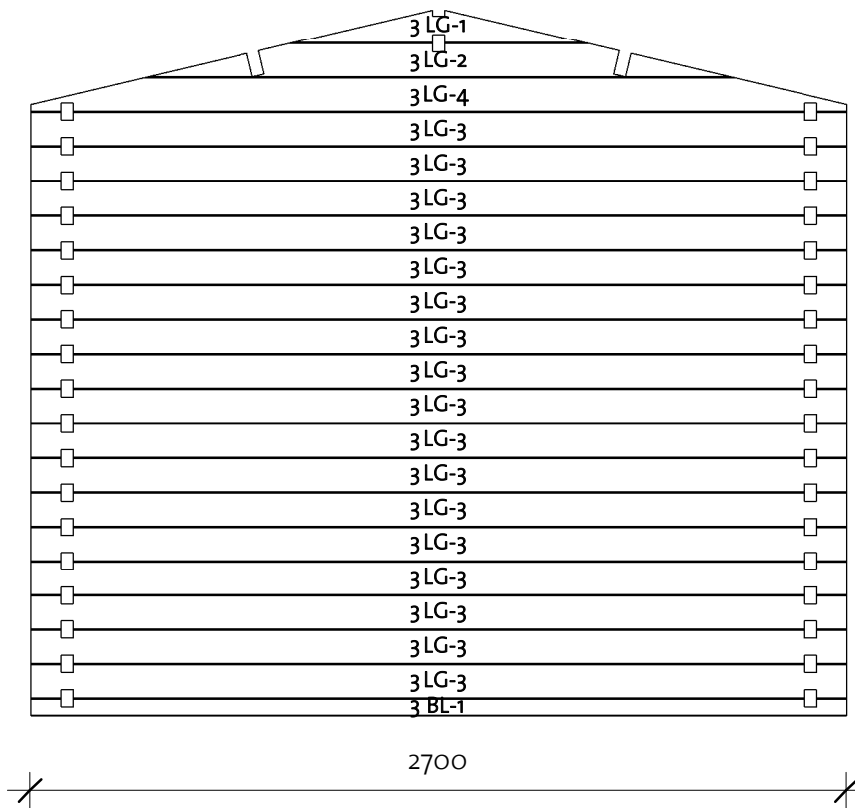
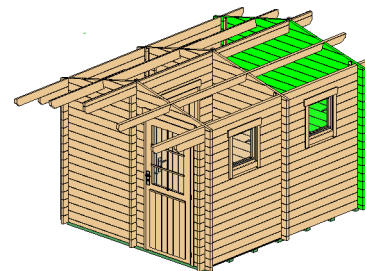

Wall 3			
Mark	Profile	Count	Cut Length

3BL-1	40x57	1	2700
3LG-1*	40x114	1	974
3LG-2*	40x114	1	1938
3LG-3	40x114	17	2700
3LG-4*	40x114	1	2700

* Gable - delivered premounted

Log Profile Wall 3	
Profile	Profile

40x57	
40x114	

Vello 2 40 (250x300)

Wall A

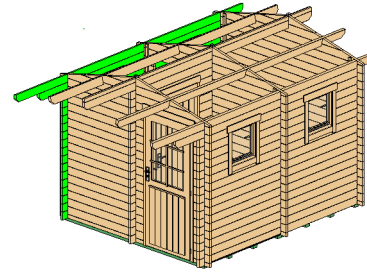

Wall A			
Mark	Profile	Count	Cut Length

ALG-1	40x114	10	588
ALG-2	40x114	11	3200
ALG-3	40x114	5	935
ALG-4	40x114	1	3650
ATL-1	40x114	1	4400

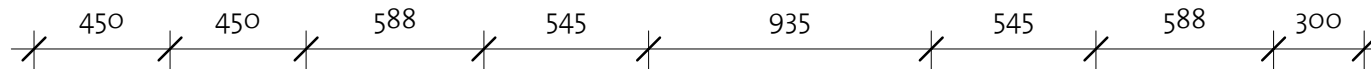
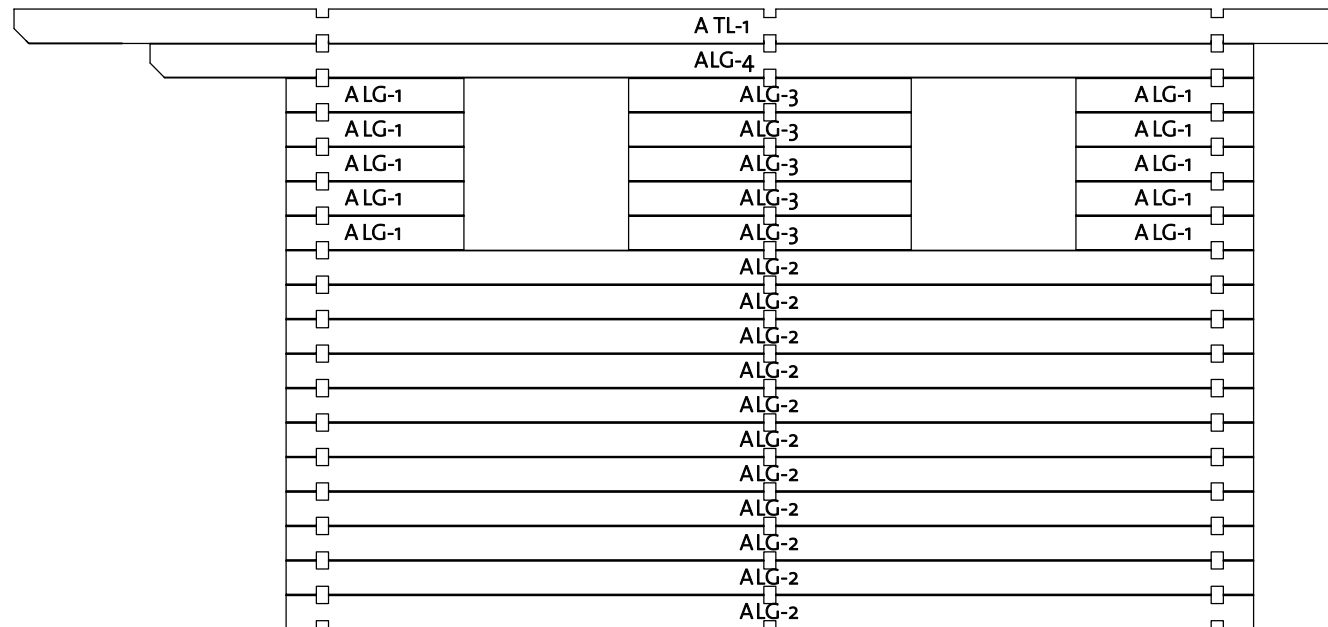

Log Profile Wall A	
Profile	Profile

40x114	
40x114	

Vello 2 40 (250x300)

Wall B

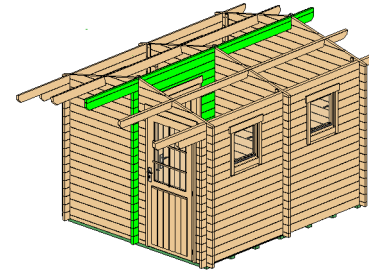

Wall B			
Mark	Profile	Count	Cut Length

BTL-1	40x58	1	4400
BLG-1	40x114	34	435
BLG-2	40x114	1	1720
BLG-3	40x114	1	4400
BLG-4	40x114	1	1720

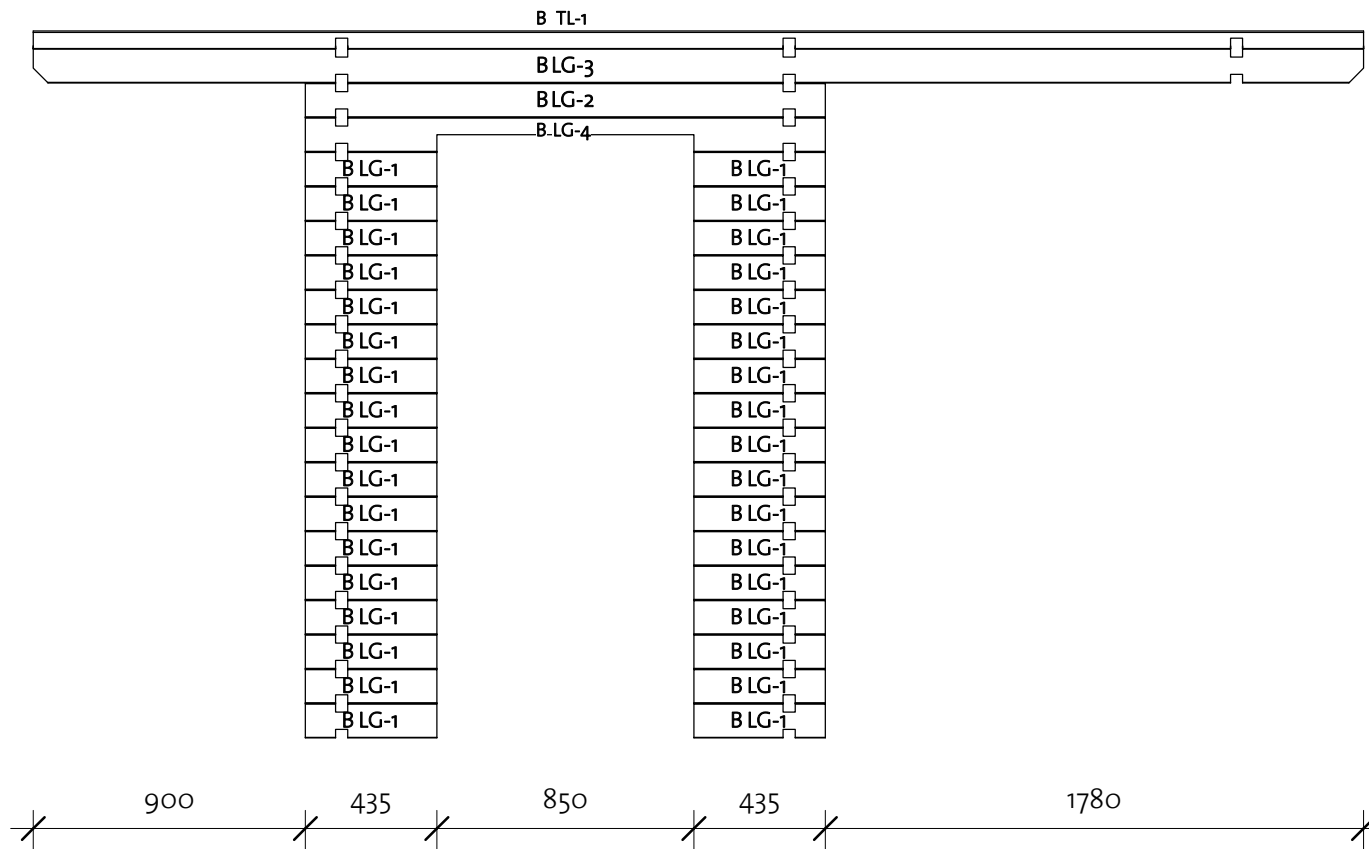

Log Profile Wall B	
Profile	Profile

40x58	
40x114	

Vello 2 40 (250x300)

Wall C

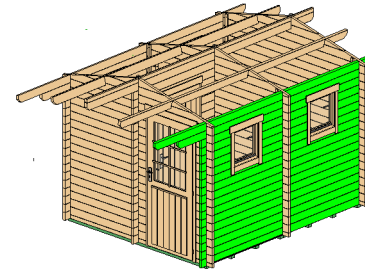

Wall C			
Mark	Profile	Count	Cut Length

CLG-1	40x114	10	588
CLG-2	40x114	5	935
CLG-3	40x114	11	3200
CLG-4	40x114	1	3650
CTL-1	40x114	1	4400

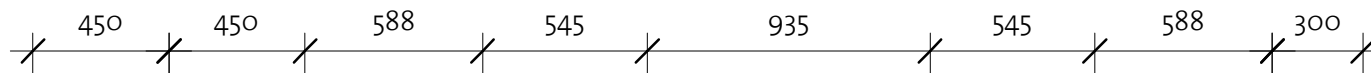
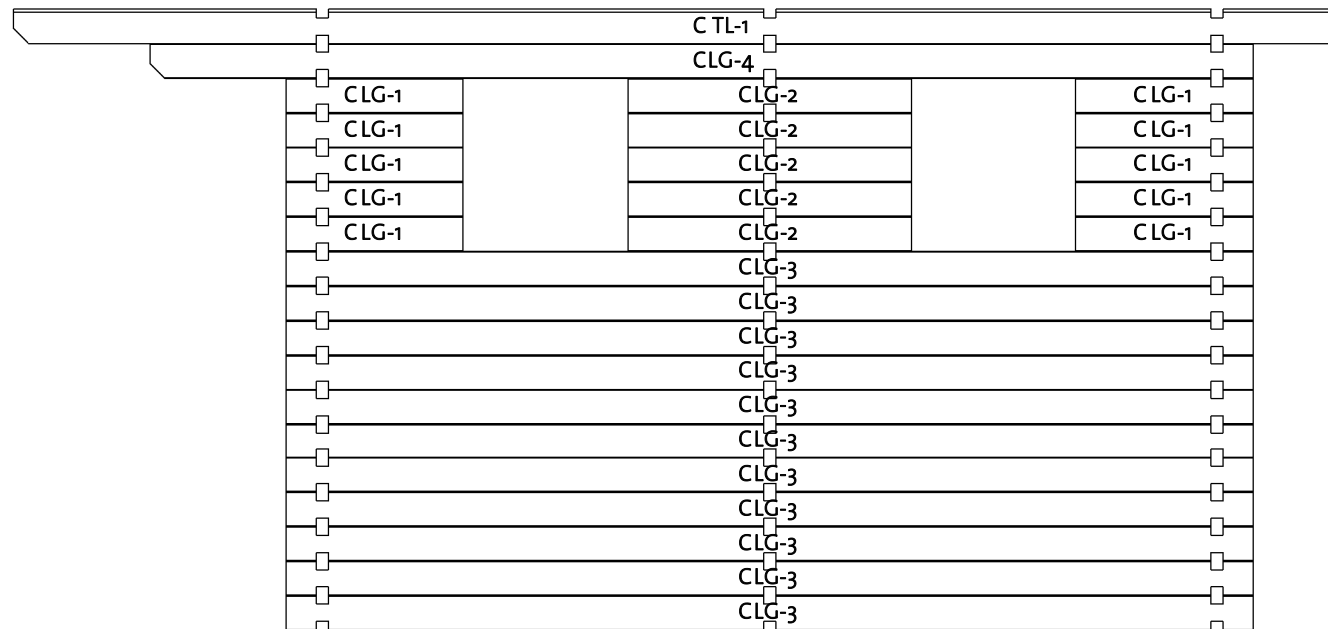



Log Profile Wall C	
Profile	Profile

40x114	
40x114	

Vello 2 40 (250x300)

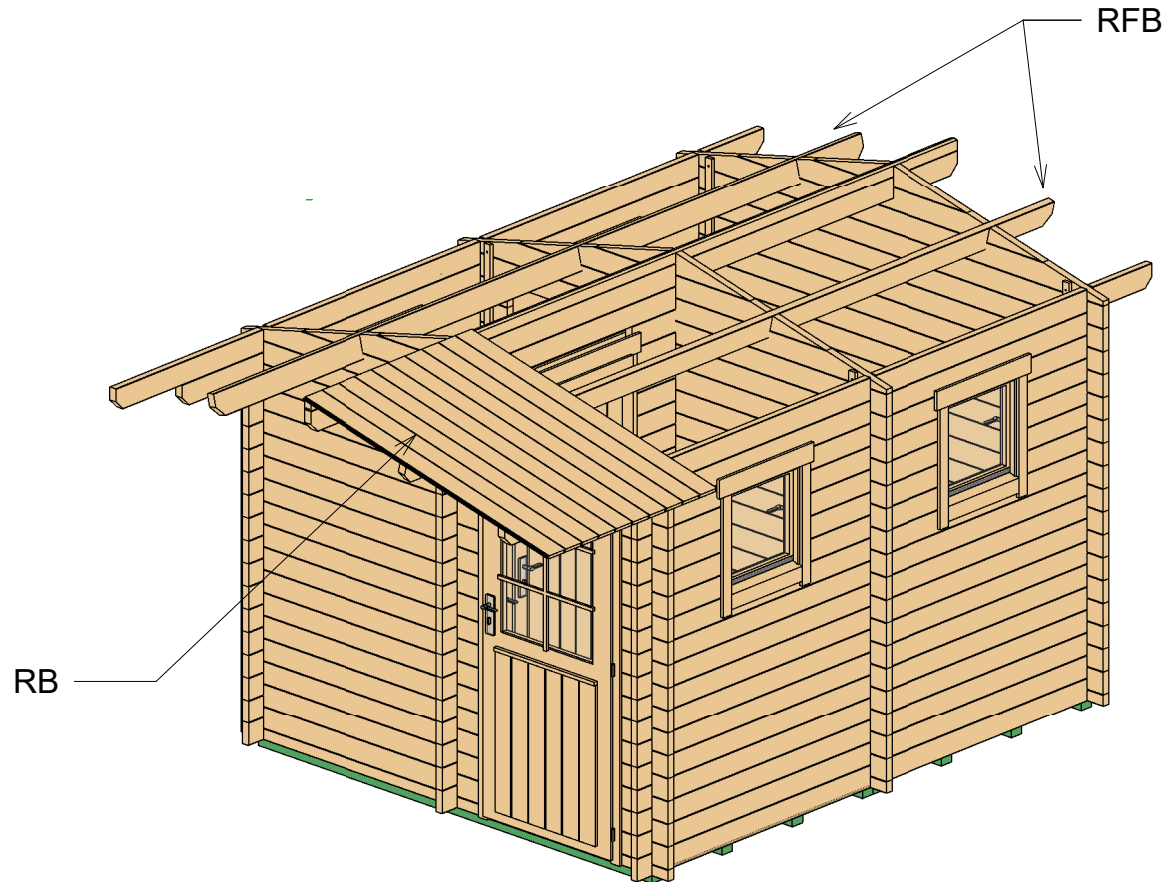
Roof 1



Roof				
Mark	Type	Profile	Count	Length
RFB	Beam 40x120		2	4400
RB	17x114		82	1589

Vello 2 40 (250x300)

Roof 2

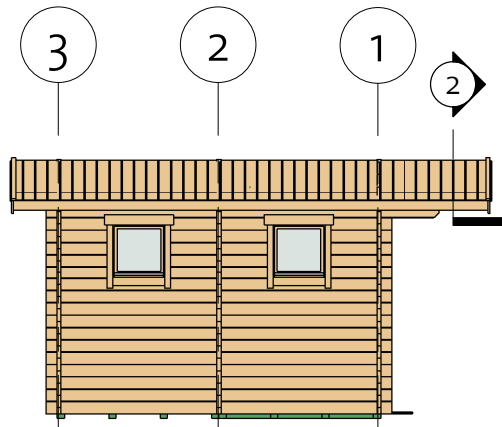

② Fasia

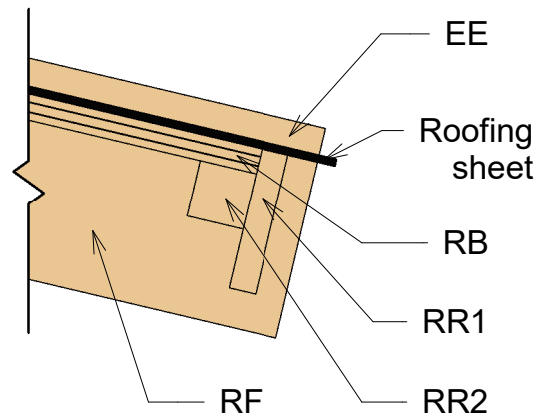

③ Roof Reinforcement

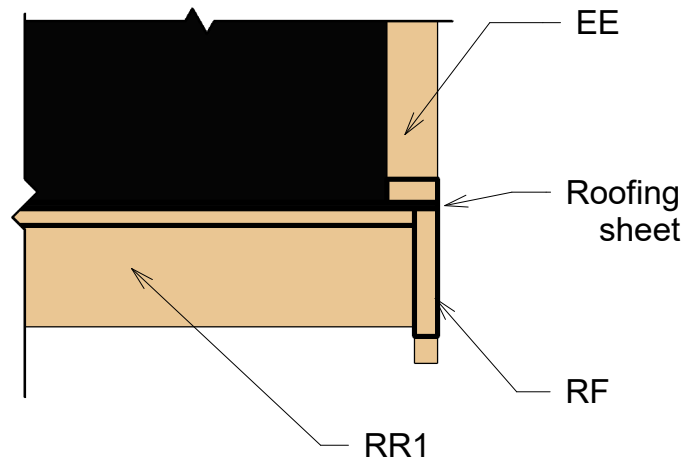
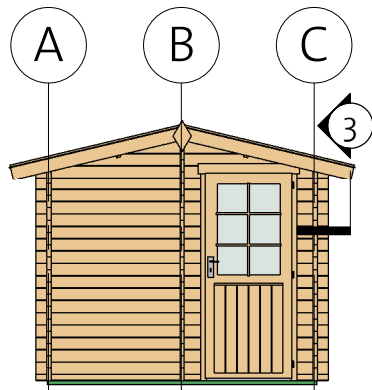

Fascia Schedule

Mark	Type	Profile	Count	Length
EE	Eave Edging 18x40		4	1631
RF	Roof Fascia 18x120		4	1631
RR1	Roof reinforce ment 18x95		2	4400
RR2	Roof reinforce ment 38x38		2	4400

Vello 2 40 (250x300)

Extras

Door Schedule				
Model	Type	Width	Height	Count
CD4R	Classic door 4 right	840	1955	1
CD7R	Classic door 7, wood right	840	1955	1
DCB6	Door Crossbar 6	--	--	1



Fasteners/Extras		
Name	Type	Count
Hitblock	300-400 mm	
Bolts	M8 x 70	18
Screws	5,0 x 70	20
Nails	1,4 x 40	50
Screws	6,0 x 140	60
Screws	4,0 x 40	80
Screws	4,0 x 50	470

Window Schedule				
Mark	Type	Width	Height	Count
CW12L	Classic window 12, full glass left	540	540	2
CW12R	Classic window 12, full glass right	540	540	2

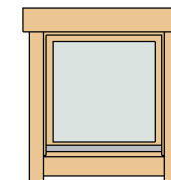

Type	Count
Romb	2



Type	Count	Length
Windboard 18x40	6	2200

Vello 2 40 (250x300)

List of all items 1

Impregnated foundation beams

Mark	Type	Profile	Count	Length
------	------	---------	-------	--------

IFB1	IFB 70x40		8	2490
------	--------------	-----------------------------------------------------------------------------------	---	------

IFB2	IFB 70x40		3	405
------	--------------	-----------------------------------------------------------------------------------	---	-----

Floor Schedule

Mark	Type	Profile	Count	Length
------	------	---------	-------	--------

FB	FB 17x114		46	1434
----	-----------	-------------------------------------------------------------------------------------	----	------

BB1	BB 20x40		3	3000
BB2	BB 20x40		4	2500

Roof

Mark	Type	Profile	Count	Length
------	------	---------	-------	--------

RFB	Beam 40x120		2	4400
-----	----------------	-------------------------------------------------------------------------------------	---	------

RB	17x114		82	1589
----	--------	-------------------------------------------------------------------------------------	----	------

Fascia Schedule

Mark	Type	Profile	Count	Length
------	------	---------	-------	--------

EE	Eave Edging 18x40		4	1631
----	-------------------------	---------------------------------------------------------------------------------------	---	------

RF	Roof Fascia 18x120		4	1631
----	--------------------------	---------------------------------------------------------------------------------------	---	------

RR1	Roof reinforce ment 18x95		2	4400
-----	------------------------------------	---------------------------------------------------------------------------------------	---	------

RR2	Roof reinforce ment 38x38		2	4400
-----	------------------------------------	---------------------------------------------------------------------------------------	---	------

Vello 2 40 (250x300)

List of all items 2

Wall 1			
Mark	Profile	Count	Cut Length

1BL-1	40X57	1	1540
1BL-2	40X57	1	310
1LG-1	40X114	17	310
1LG-2*	40X114	1	974
1LG-3	40X114	17	1540
1LG-4*	40X114	1	2700
1LG-5*	40X114	1	1938

Wall 2			
Mark	Profile	Count	Cut Length

2BL-1	40X57	1	310
2BL-2	40X57	1	1540
2LG-1	40X114	16	310
2LG-2*	40X114	1	974
2LG-3	40X114	16	1540
2LG-4*	40X114	1	1938
2LG-5	40X114	1	2700
2LG-6*	40X114	1	2700

Wall 3			
Mark	Profile	Count	Cut Length

3BL-1	40X57	1	2700
3LG-1*	40X114	1	974
3LG-2*	40X114	1	1938
3LG-3	40X114	17	2700
3LG-4*	40X114	1	2700

Wall A			
Mark	Profile	Count	Cut Length

ALG-1	40X114	10	588
ALG-2	40X114	11	3200
ALG-3	40X114	5	935
ALG-4	40X114	1	3650
ATL-1	40X114	1	4400

* Gable - delivered premounted

Wall B			
Mark	Profile	Count	Cut Length

BTL-1	40X58	1	4400
BLG-1	40X114	34	435
BLG-2	40X114	1	1720
BLG-3	40X114	1	4400
BLG-4	40X114	1	1720

Wall C			
Mark	Profile	Count	Cut Length

CLG-1	40X114	10	588
CLG-2	40X114	5	935
CLG-3	40X114	11	3200
CLG-4	40X114	1	3650
CTL-1	40X114	1	4400

Vello 2 40 (250x300)

List of all items 3

Log profiles	
Profile	Profile

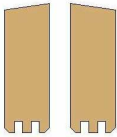
40x57	
40x114	

Log profiles	
Profile	Profile

40x114	
40x58	