

# Colorado 28 (274x335)

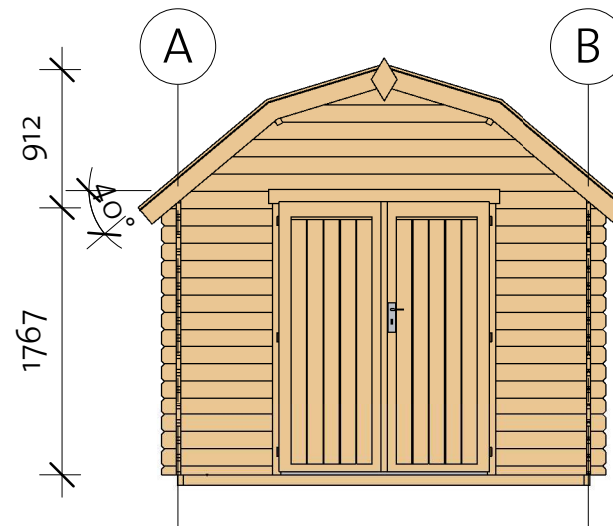

# Colorado 28 (274x335)

Foundation

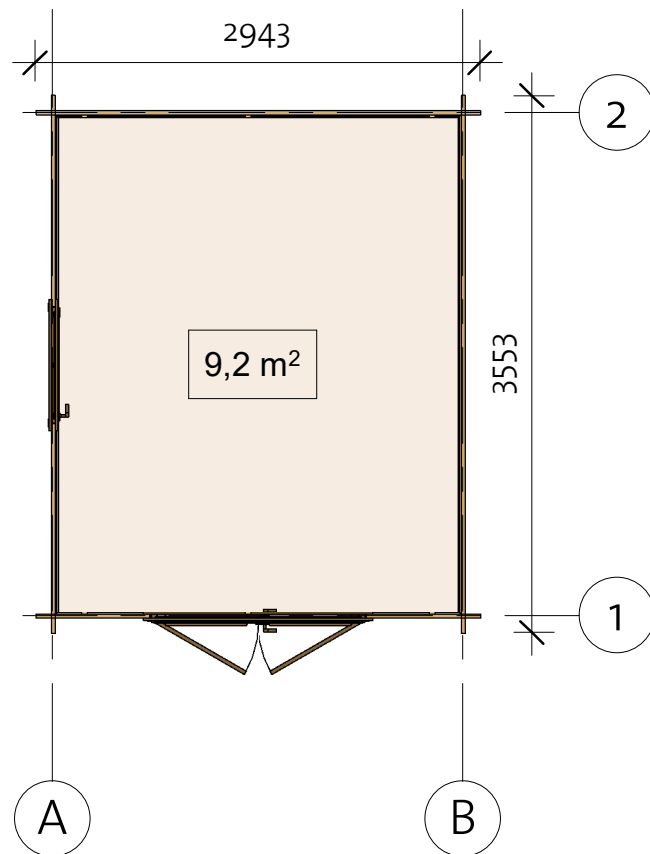
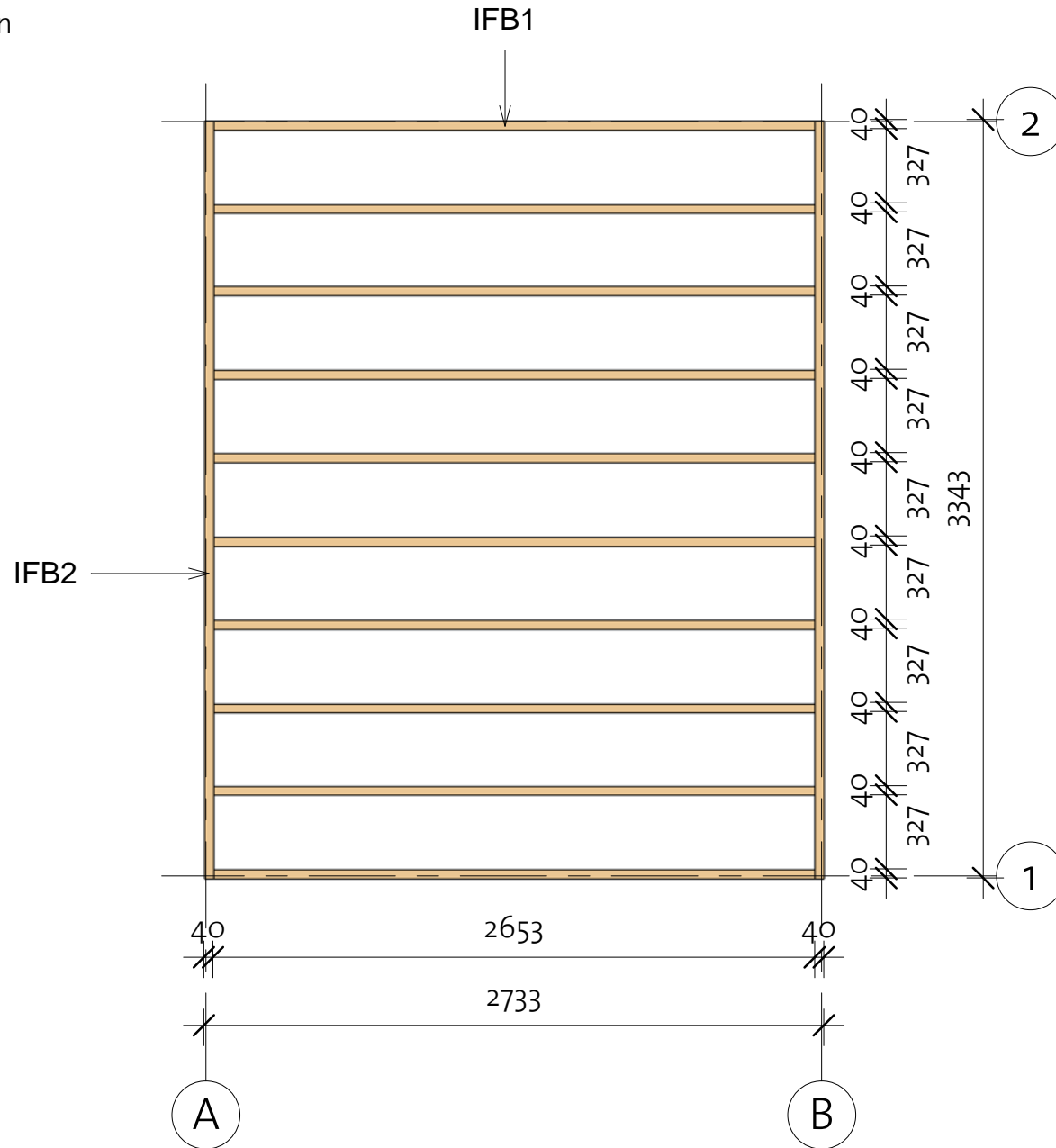

Impregnated foundation beams				
Mark	Type	Profile	Count	Length

IFB1	IFB 40x70		10	2653
IFB2	IFB 40x70		2	3343

# Colorado 28 (274x335)

Floor Plan

① Baseboard

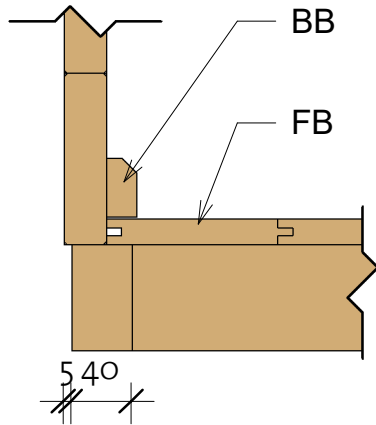

Floor Schedule

Mark	Type	Profile	Count	Length
FB	FB 17x114		25	3294
BB1	BB 20x40		2	3300
BB2	BB 20x40		2	2700

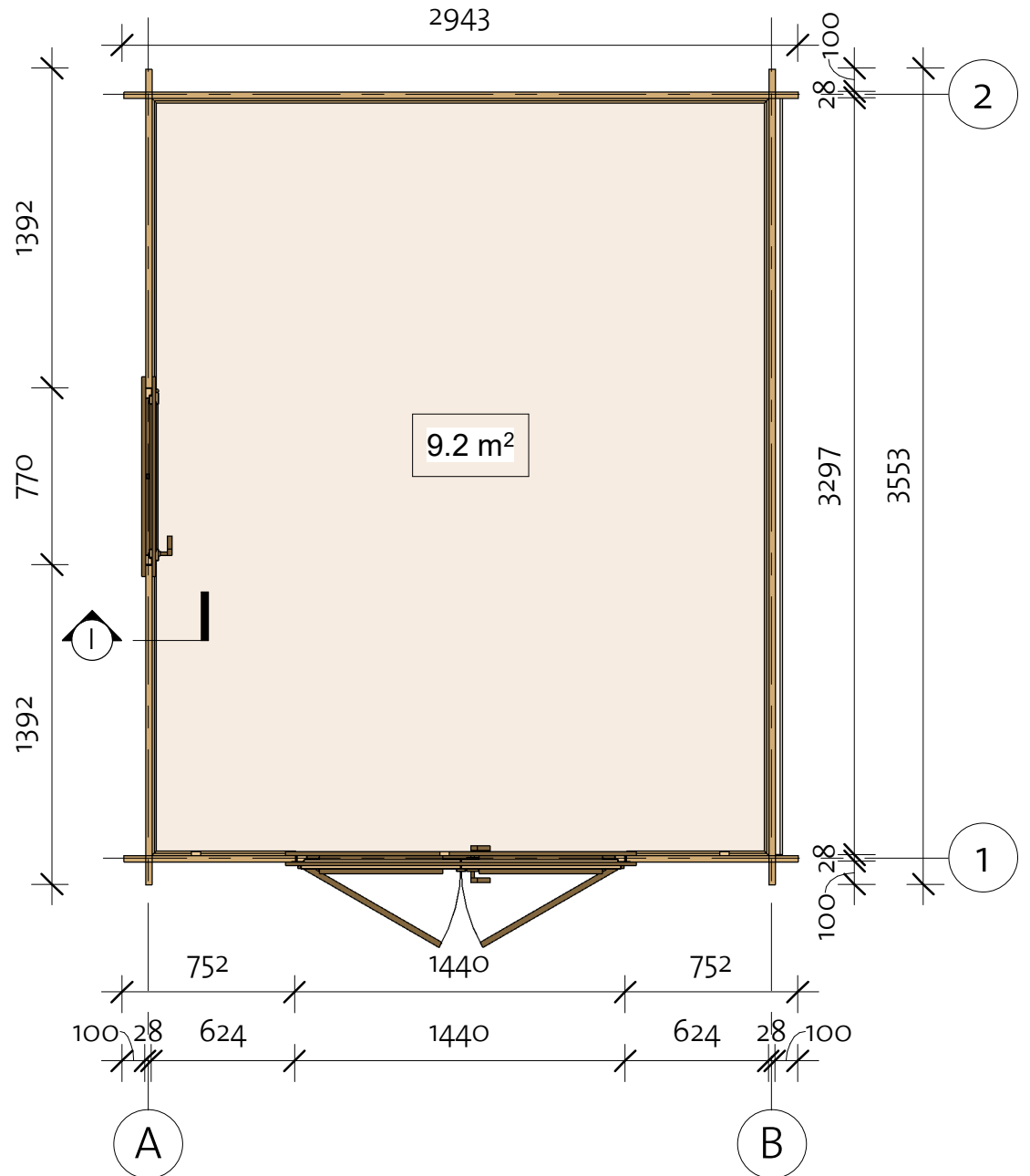

# Colorado 28 (274x335)

Wall 1

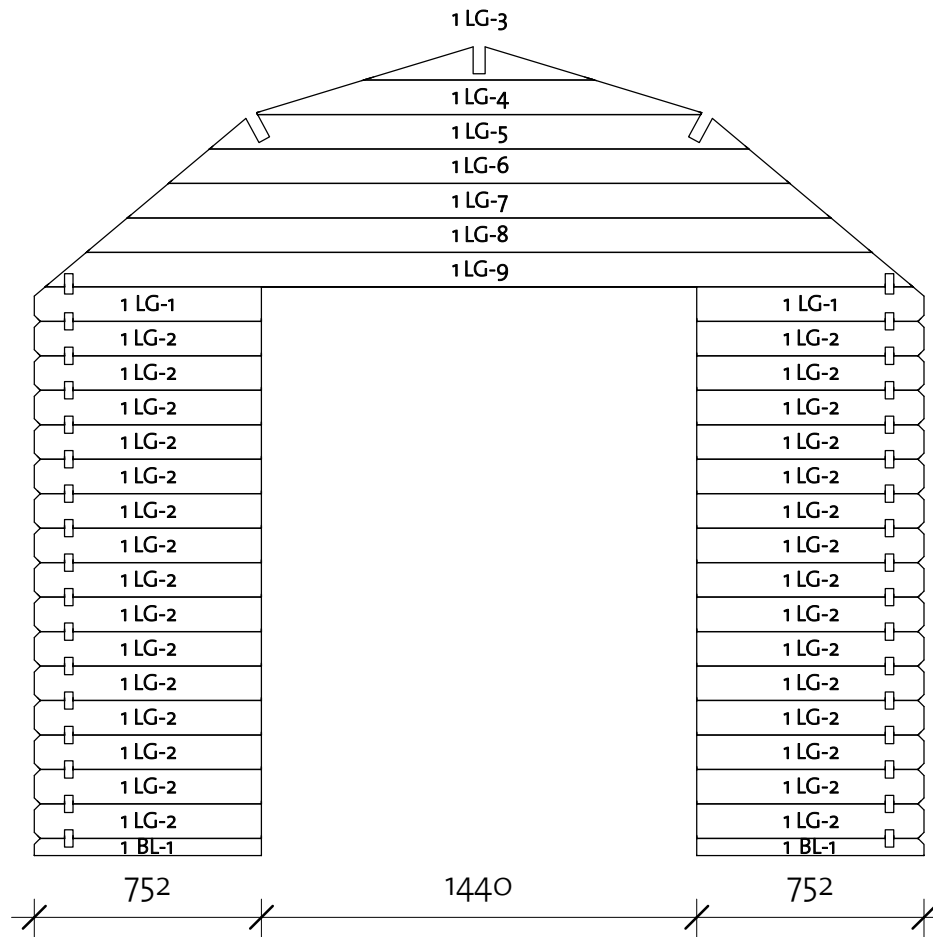
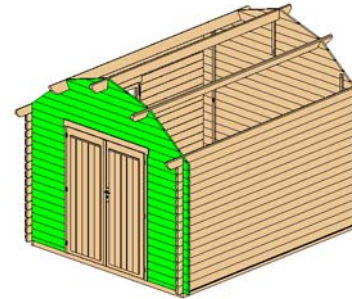

Wall 1			
Mark	Profile	Count	Cut Length

1BL-1	28x57	2	752
1LG-1	28x114	2	752
1LG-2	28x114	30	752
1LG-3 *	28x114	1	763
1LG-4 *	28x114	1	1473
1LG-5**	28x114	1	1784
1LG-6**	28x114	1	2055
1LG-7**	28x114	1	2327
1LG-8**	28x114	1	2599
1LG-9**	28x114	1	2870

\* Gable 1 - delivered premounted

\*\* Gable 2 - delivered premounted

Log Profile Wall 1	
Profile	Profile

28x57	
28x114	



# Colorado 28 (274x335)

Wall A

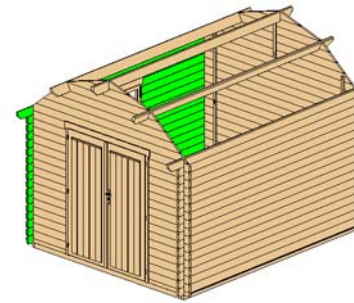

Wall A			
Mark	Profile	Count	Cut Length

ALG-1	28x114	18	1392
ALG-2	28x114	7	3553
ATL-1	28x123	1	3853

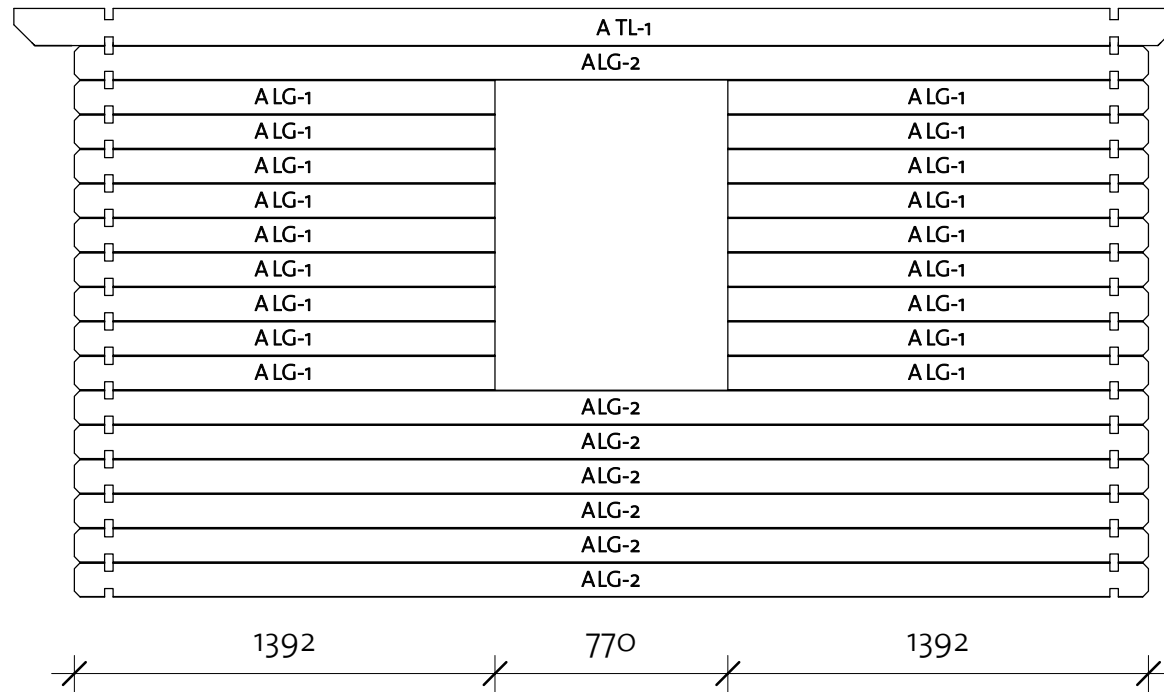

Log Profile Wall A	
Profile	Profile

28x114	
28x123	

# Colorado 28 (274x335)

Wall B

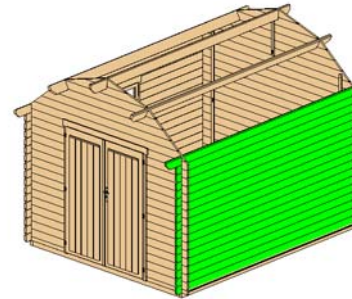

Wall B			
Mark	Profile	Count	Cut Length

BLG-1	28x114	16	3553
BTL-1	28x123	1	3853

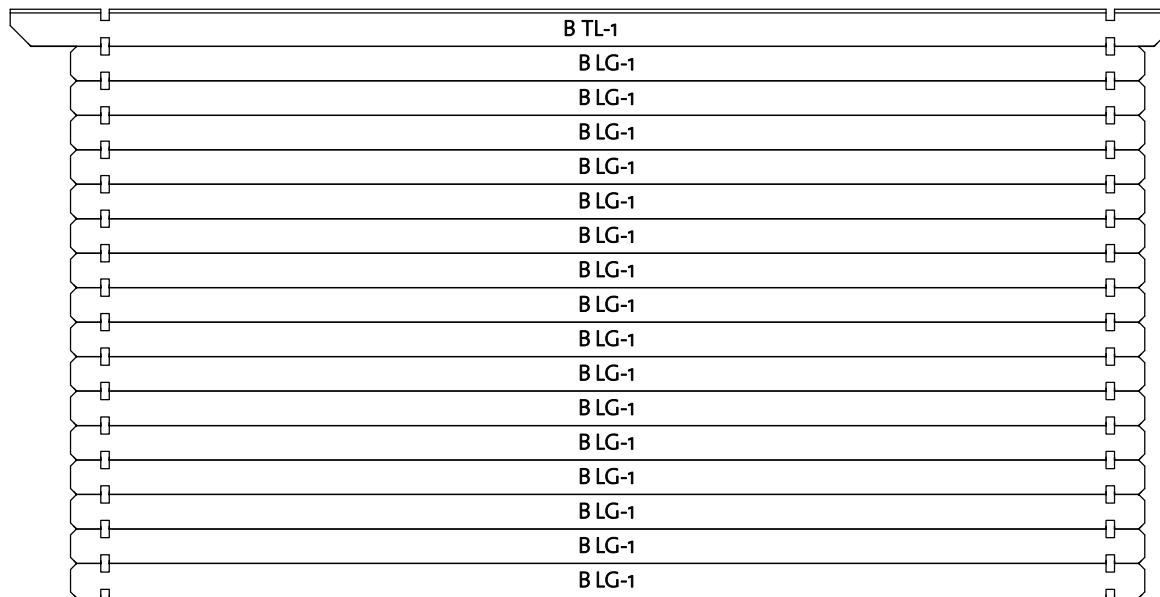

3553

190306





Log Profile Wall B	
Profile	Profile

28x114	
28x123	

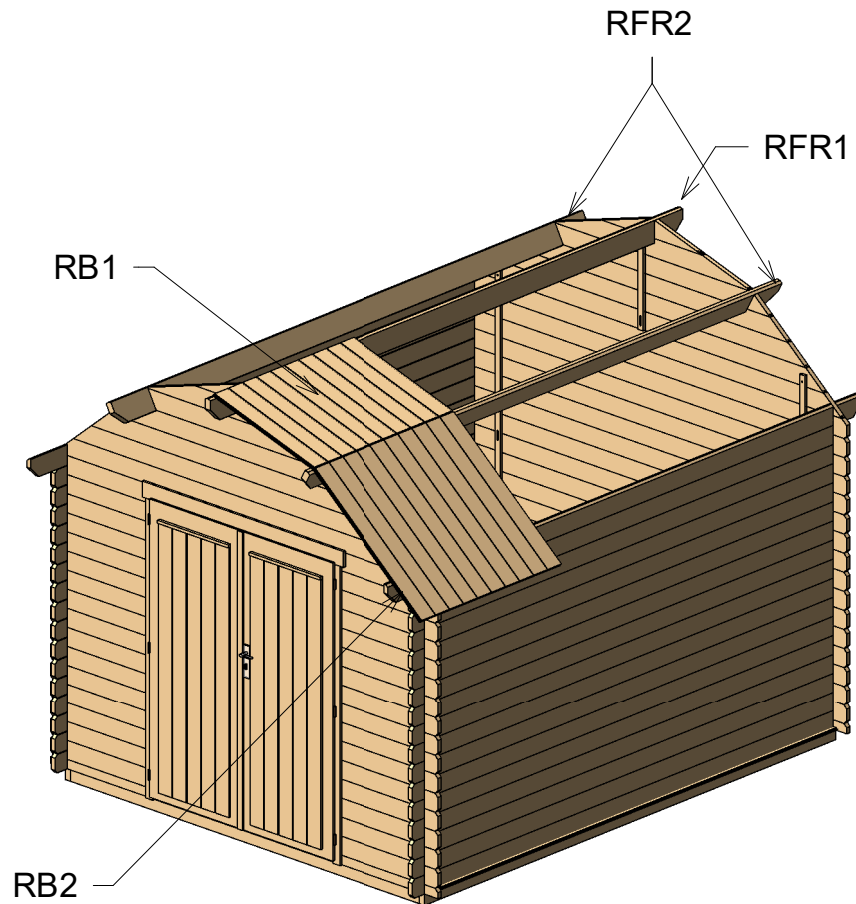
# Colorado 28 (274x335)

Roof 1



Roof				
Mark	Type	Profile	Count	Length
RFR1	Ridge 40x143		1	3853
RFR2	Ridge 40x143		2	3853
RB1	17x114		68	790
RB2	17x114		68	1065



# Colorado 28 (274x335)

Roof 2

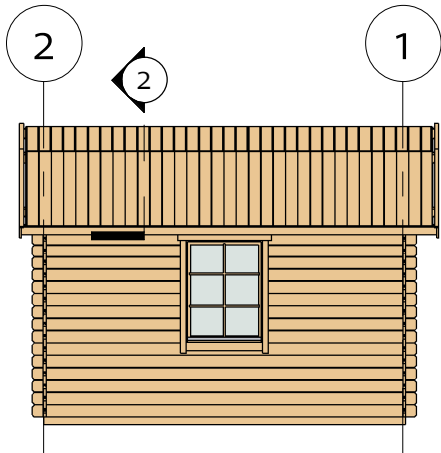

② Fascia

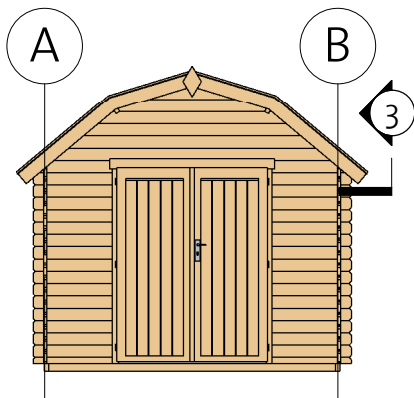
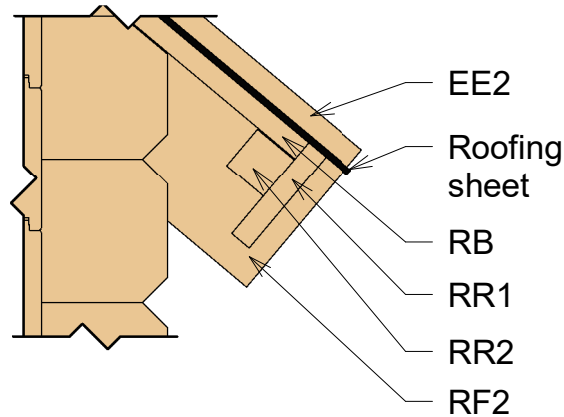

③ Roof Reinforcement

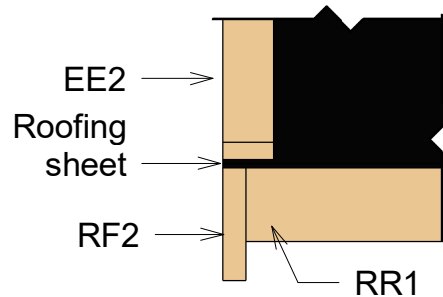

Fascia Schedule

Mark	Type	Profile	Count	Length
EE1	Eave Edging 18x40		4	799
EE2	Eave Edging 18x40		4	1105
RF1	Roof Fascia 18x120		4	799
RF2	Roof Fascia 18x120		4	1105
RR1	Roof reinforcement 18x95		2	3853
RR2	Roof reinforcement 38x38		2	3853

# Colorado 28 (274x335)

Extras

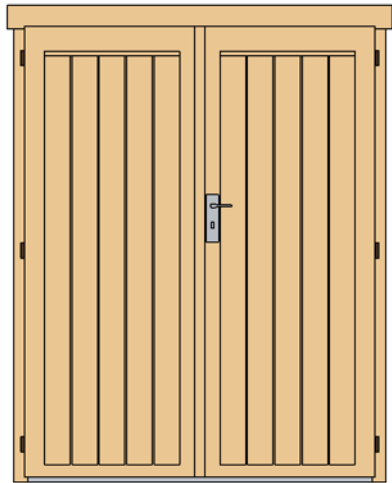

Door Schedule				
Mark	Type	Width	Height	Count
BDD6R	Basic double door 6, wood right	1425	1835	1

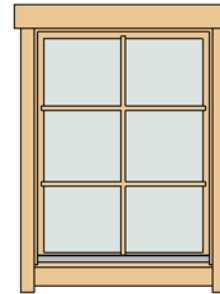

Window Schedule				
Mark	Type	Width	Height	Count
BW1R	Basic window 1 right	765	990	1
WCB6	Windows Crossbar 6	--	--	1

Fasteners & Extras		
Name	Type	Count

Hitblock	300-400 mm	
Screws	5,0 x 70	15
Bolt	M8 x 60	16
Nails	1,4 x 40	40
Screws	6,0 x 140	60
Screws	4,0 x 40	90
Screws	4,0 x 50	600

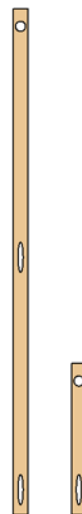

Type	Count	Length
Windboard1 18x40	4	2010
Windboard 2 18x40	2	600



Type	Count
Romb	2

190306





# Colorado 28 (274x335)

## List of all items 1

### Impregnated foundation beams

Mark	Type	Profile	Count	Length
IFB1	IFB 40x70		10	2653
IFB2	IFB 40x70		2	3343

### Roof







Mark	Type	Profile	Count	Length
RFR1	Ridge 40x143		1	3853
RFR2	Ridge 40x143		2	3853
RB1	17x114		68	790
RB2	17x114		68	1065

91808178\_201203

### Floor Schedule

Mark	Type	Profile	Count	Length
FB	FB 17x114		25	3294
BB1	BB 20x40		2	3300
BB2	BB 20x40		2	2700

### Fascia Schedule

Mark	Type	Profile	Count	Length
EE1	Eave Edging 18x40		4	799
EE2	Eave Edging 18x40		4	1105
RF1	Roof Fascia 18x120		4	799
RF2	Roof Fascia 18x120		4	1105
RR1	Roof reinforcement 18x95		2	3853
RR2	Roof reinforcement 38x38		2	3853

# Colorado 28 (274x335)

## List of all items 2

Wall 1			
Mark	Profile	Count	Cut Length

1BL-1	28x57	2	752
1LG-1	28x114	2	752
1LG-2	28x114	30	752
1LG-3 *	28x114	1	763
1LG-4 *	28x114	1	1473
1LG-5**	28x114	1	1784
1LG-6**	28x114	1	2055
1LG-7**	28x114	1	2327
1LG-8**	28x114	1	2599
1LG-9**	28x114	1	2870

Wall 2			
Mark	Profile	Count	Cut Length

2BL-1	28x57	1	2943
2LG-1*	28x114	1	763
2LG-2*	28x114	1	1473
2LG-3**	28x114	1	1784
2LG-4**	28x114	1	2055
2LG-5**	28x114	1	2327
2LG-6**	28x114	1	2599
2LG-7**	28x114	1	2870
2LG-8	28x114	1	2943
2LG-9	28x114	15	2943

Wall A			
Mark	Profile	Count	Cut Length

ALG-1	28x114	18	1392
ALG-2	28x114	7	3553
ATL-1	28x123	1	3853



\* Gable 1 - delivered premounted

Wall B			
Mark	Profile	Count	Cut Length

BLG-1	28x114	16	3553
BTL-1	28x123	1	3853

\*\* Gable 2 - delivered premounted

Log Profiles	
Profile	Profile

28x57	
28x114	

Log Profiles	
Profile	Profile

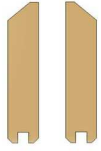
28x123	
--------	---