

WALL LOG (mm): 28

SIZE (mm): 2950x2000

BUILDING CODE

Sten

COMPONENT SPECIFICATION

NUMBER	COMPONENT FUNCTION	COMPONENT CODE	VIEW	SIDE VIEW	DIMENSIONS (mm)			QUANTITY (psc.)
					LENGTH	WIDTH	THICKNESS	
1	Wall board	A2			1690	115	28	9
2	Wall board	A3			1690	115	28	1
3	Wall board	A4			410	115	28	16
4	Wall board	A5			410	115	28	6
5	Wall board	A6			410	115	28	6
6	Wall board	B2			2950	115	28	16
7	Wall board	C1, D1			2000	115	28	32
8	Wall board	C2, D2			2200	115	28	2
9	Wall board	A1, B1			2950	60	28	2
10	Apex	A7		2950		28	1	
11	Apex	B3		2950		28	1	
12	Door	D-6			1880	830		1
13	Window	W-3			850	680		1
14	Roof board				1650	135	19	34
15	Fascia board				1700	120	16	4
16	Roof cover fixture				2200	50/38	16	2
17	Diamond							2
18	Beam				2200	120	40	3
19	Roof cover fixture				1700	50/38	16	4
20								
21								
22								
23								
24								
25								

PACKAGE NR.:

MNFCT. ORDER NR.:

CONTROL 1

SIGNATURE

CONTROL 2

SIGNATURE

PAGE/PAGES: **1/6**

BUILDING CODE

Sten

WALL LOG (mm): 28

SIZE (mm): 2950x2000

ISOMETRIC VIEW



TOP VIEW

A-FRONT
B-BACK
C-LEFT
D-RIGHT

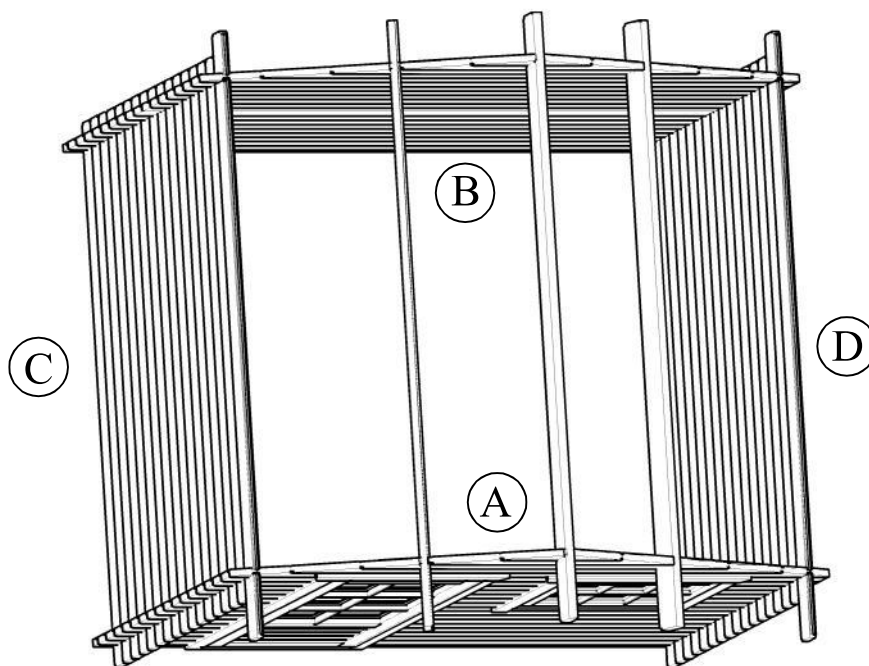

PACKAGE NR.:

MNFCT. ORDER NR.:

CONTROL 1
SIGNATURE

CONTROL 2
SIGNATURE

PAGE/PAGES: **2/6**

BUILDING CODE

Sten

WALL LOG (mm): 28

SIZE (mm): 2950x2000

FRONT VIEW

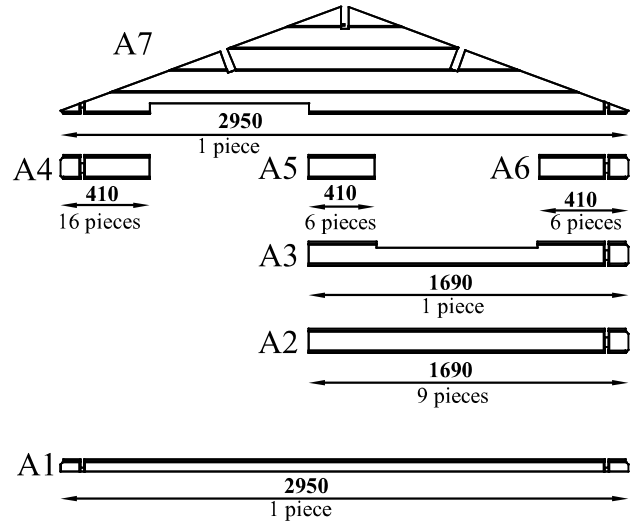
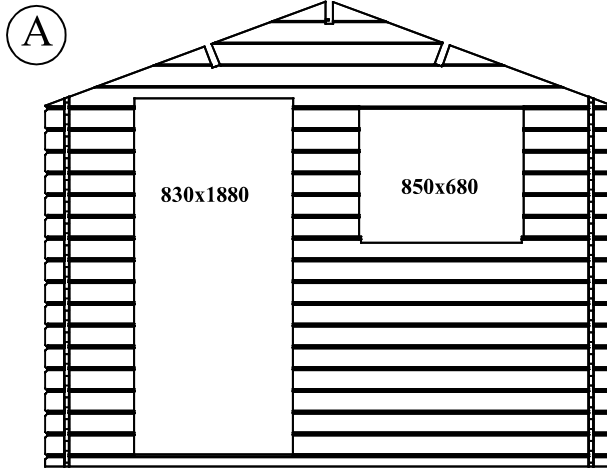

BACK VIEW

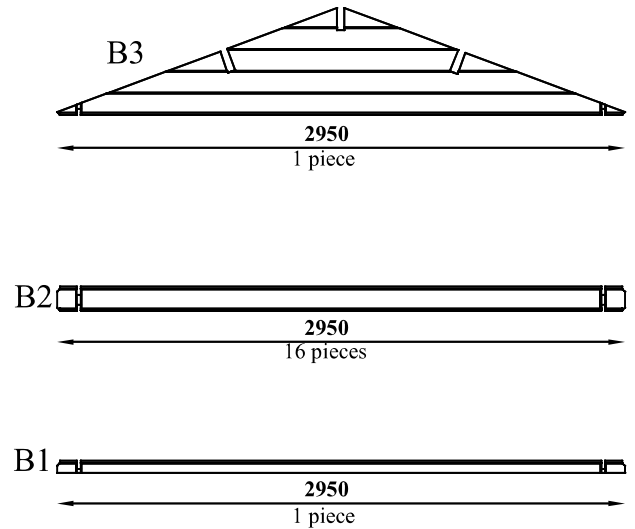
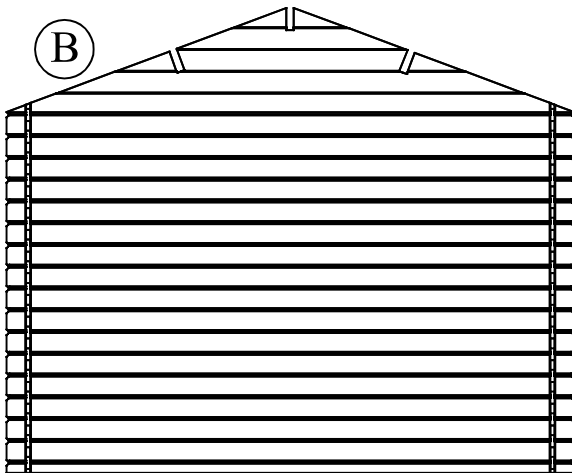

PACKAGE NR.:

MNFCT. ORDER NR.:

CONTROL 1

CONTROL 2

SIGNATURE

SIGNATURE

PAGE/PAGES:

3/6

BUILDING CODE

Sten

WALL LOG (mm): 28

SIZE (mm): 2950x2000

LEFT VIEW

Ⓒ

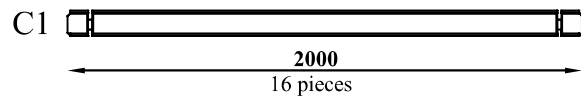
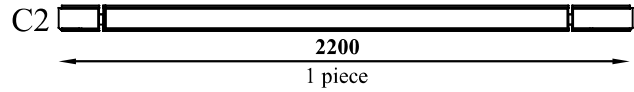
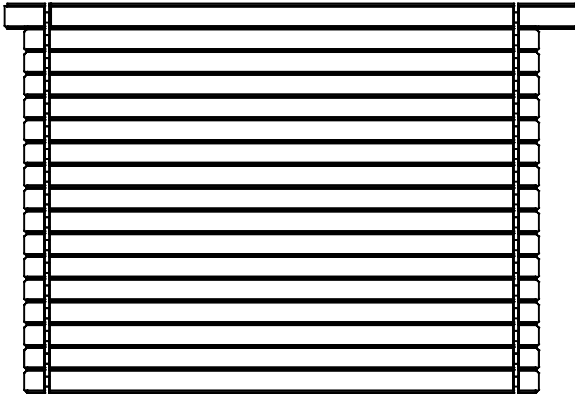

RIGHT VIEW

Ⓓ

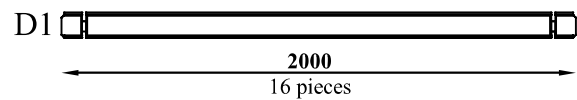
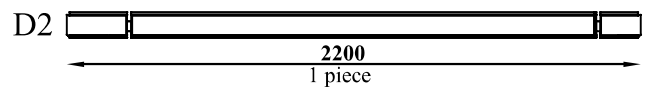
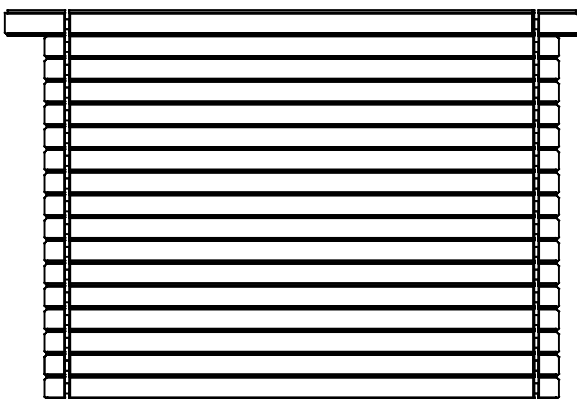

PACKAGE NR.:

MNFCT. ORDER NR.:

CONTROL 1

CONTROL 2

PAGE/PAGES:

4/6

SIGNATURE

SIGNATURE

BUILDING CODE

Sten

WALL LOG (mm): 28

SIZE (mm): 2950x2000

CONSTRUCTION 1

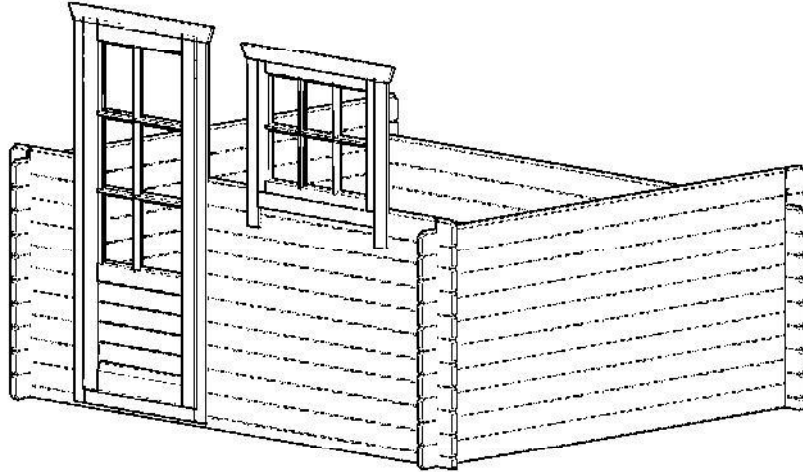

CONSTRUCTION 2

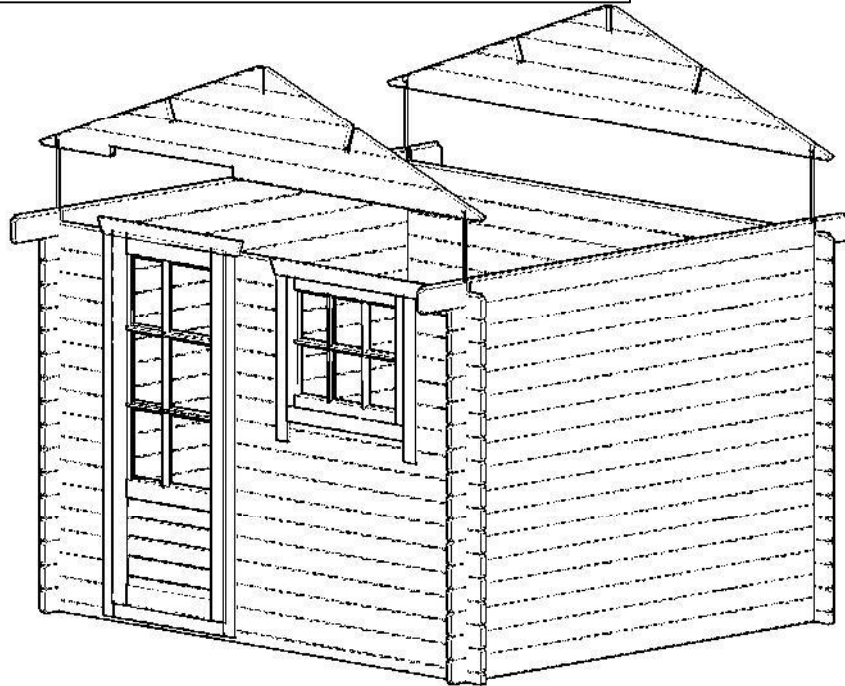

PACKAGE NR.:

MNFCT. ORDER NR.:

CONTROL 1

CONTROL 2

PAGE/PAGES: **5/6**

SIGNATURE

SIGNATURE

BUILDING CODE

Sten

WALL LOG (mm): 28

SIZE (mm): 2950x2000

CONSTRUCCION 3

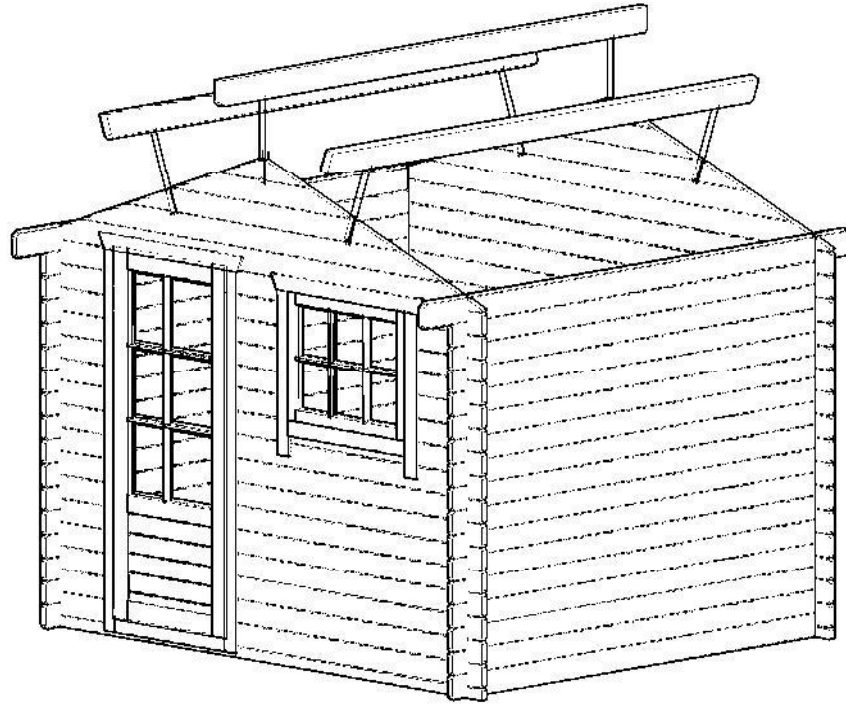

CONSTRUCCION 4

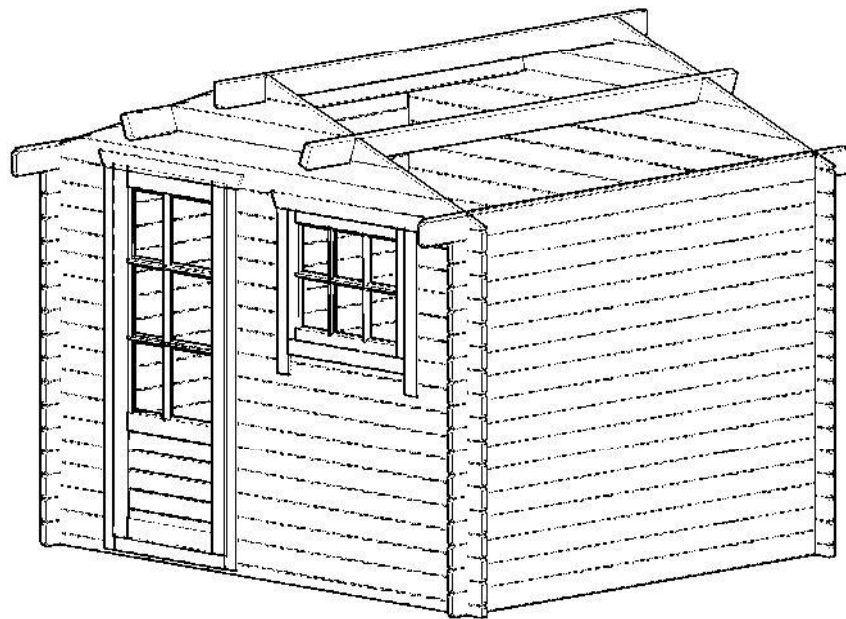

PACKAGE NR.:

MNFCT. ORDER NR.:

CONTROL 1

CONTROL 2

PAGE/PAGES:

6/6

SIGNATURE

SIGNATURE